

INSTRUCTION MANUAL FR-101

YAESU MUSEN CO., LTD.

TOKYO JAPAN

TABLE OF CONTENTS

GENERAL DESCRIPTION	Page 1
SPECIFICATIONS	Page 2
INSTALLATION	Page 3
CONTROLS AND SWITCHES	Page 4
OPERATION	Page 7
CIRCUIT DESCRIPTION	Page 15
ALIGNMENT	Page 19
RESISTANCE & VOLTAGE MEASUREMENTS	Page 27
PARTS LIST	Page 28

This manual is revised for the units produced starting with Lot No. 017 and the lots produced subsequently.

Copyright of
Yaesu Musen Co. Ltd.

FR-101

COMMUNICATIONS RECEIVER



GENERAL DESCRIPTION

The model FR-101 is a solid-state communications receiver designed to provide extreme flexibility that even the most demanding amateur desires with provisions for all mode reception on twenty one 500 KHz amateur and major shortwave broadcast bands from 160 through 2 meters. The versatile FR-101 receiver is capable of transceive or independent receive and transmit function with the matching FL-101 transmitter or FT-101E/277E transceiver.

New, solid-state technology, with features such as a double-balanced mixer, offer unparalleled performance and rejection of cross-modulation and intermodulation interference. All circuits are composed of standard, computer type, plug-in modules, for reliable operation and service simplicity. A linear tuning, temperature compensated VFO with 1 KHz frequency readability is

incorporated. A 100 KHz/25 KHz crystal calibrator is built-in. The FR-101 also includes fast attack/slow release AGC for SSB or AM and fast release for CW. If desired, the AGC can be completely disabled. A built-in noise blanker with adjustable threshold control provides excellent elimination of most impulse type noise.

In addition to external VFO operation, a crystal oscillator is built-in for crystal-control operation of 4 channels of fixed frequency reception. The FR-101 includes a self-contained AC power supply - adjustable from 100/110/117/200/220/234 volt AC when the primary power transformer winding is appropriately wired.

The SP-101PB/277PB phone-patch and external speaker combination is a useful accessory for amateur operation.

SPECIFICATIONS

Frequency Range:

160m	1.8 ~ 2.0 MHz	
80	3.5 ~ 4.0	
60	4.5 ~ 5.0*	
40	7.0 ~ 7.5	
31	9.5 ~ 10.0*	
25	11.5 ~ 12.0*	
20	14.0 ~ 14.5	
19	15.0 ~ 15.5*	
16	17.5 ~ 18.0*	
15	21.0 ~ 21.5	
13	21.5 ~ 22.0*	
11	25.5 ~ 26.0*	
CB	27.0 ~ 27.5*	
10A	28.0 ~ 28.5	
10B	28.5 ~ 29.0	
10C	29.0 ~ 29.5*	
10D	29.5 ~ 29.9*	
VHF 6m	50.0 ~ 52.0* 52.0 ~ 54.0*	
VHF 2m	144 ~ 146* 146 ~ 148*	
☆1	4.0 ~ 4.5**	
☆2	5.0 ~ 5.2**	
☆3	7.5 ~ 9.0**	
☆4	22.0 ~ 27.0**	

Type of Emission:

USB, LSB, CW, AM, FM* or RTTY

Frequency Stability:

Within 100 Hz during any 30 minute period after warm-up. Not more than 100 Hz with 10% line voltage variation.

Calibration Accuracy:

1 KHz maximum after 100 KHz calibration.

Backlash:

Not more than 50 Hz.

Antenna Impedance:

50 ohm unbalanced nominal.

Power Requirement:

100/110/117/200/220/234 volt AC 50/60 Hz or 13.5 volt DC nominal.

Sensitivity:

SSB and CW...0.3 μ V for 10 dB Noise plus Signal to Noise Ratio on 14 MHz.

AM.....1 μ V on 14 MHz.

FM.....12 dB SINAD

Selectivity:

CW·N*0.6 KHz/6 dB, 1.5 KHz/60 dB

CW, SSB, RTTY, AM·N

.....2.4 KHz/6 dB, 4 KHz/60 dB

AM·W*.....6 KHz/6 dB, 12 KHz/50 dB

FM*.....20 KHz/6 dB, 45 KHz/50 dB

Harmonic & Other Spurious Response:

Image Rejection Better than 60 dB.

Internal Spurious Signal ... Below 1 μ V equivalent to antenna input.

Automatic Gain Control:

AGC threshold nominal 1 μ V.

Selectable AGC time constant, fast or slow.

Fast attack time 3 milli-second and slow attack time 4 milli-second. Fast release time 0.5 second and slow release time 2 seconds.

Audio Noise Level:

Not less than 40 dB below 1 watt.

Audio Output:

2 watts at 4 ohm impedance.

Audio Distortion:

Less than 10% at 2 watts output.

Dimensions:

340(W) x 153(H) x 285(D) mm.

Weight:

9 Kg.

*Options for FR-101 Standard Type Receiver.

**Options for FR-101 Standard and Deluxe Type Receives.

SEMICONDUCTORS

Silicon TR:

18 x 2SC372Y, 1 x 2SC784R, 6 x 2SC735Y

1 x 2SA634

FET:

8 x 2SK19GR, 3 x 3SK35, 1 x 3SK40M

IC:

1 x AN214, 1 x TA7061AP, 2 x CA3053,

1 x MC1496G, 1 x μ PC-141C

Diode:

2 x 1S2236, 1 x 1S2689, 5 x WZ090, 1 x WZ0109,

1 x 1S993, 6 x 1S1555, 14 x 1S1007,

4 x 1S188FM, 4 x V06B, 2 x TLR104

INSTALLATION

GENERAL

Carefully remove the FR-101 receiver from the carton and examine it for any physical damage. Should any be apparent, notify the carrier immediately, stating the damage in detail. Save the carton and packing materials for future use.

LOCATION

In general, the location of the FR-101 is not critical, however it is recommended that excessively warm locations be avoided. The FR-101 should be placed in a location that has adequate space to permit free air circulation through the cabinet opening.

POWER REQUIREMENT

Two prewired plugs are furnished with the unit for AC or DC voltage operation. The FR-101 is supplied with a multi-voltage power transformer and can be operated in many areas of the world where voltages may differ from your local supply voltage. Therefore, before connecting the AC cord to the power outlet, be sure that the voltage marked on the rear of the receiver agrees with the local AC supply voltage.

CAUTION

PERMANENT DAMAGE WILL RESULT IF IMPROPER AC SUPPLY VOLTAGE IS APPLIED TO THE RECEIVER.

The FR-101 will operate satisfactorily from 12 volt, negative ground battery source by connecting the DC power cord to the rear panel receptacle. The receiver requires an average of 0.5 amp. When making connections to the battery, be certain that the RED lead is connected to the positive (+) and the BLACK lead to the negative (-) terminals of the battery. Reversed connection could permanently damage the receiver circuitry.

ANTENNA AND GROUND

The FR-101 is designed for use with a resonant antenna at the operating frequency and having an impedance of 50 to 75 ohms. This requirement is easily met by using a center-fed dipole antenna resonated to the receiving frequency and fed with coaxial cable. For amateur band operation, any commercially designed antenna system with an impedance of 50 to 75 ohms may be used.

If a tuned, open-wire transmission line or a long wire antenna is used, a suitable antenna tuner must be used between the receiver and antenna. For more detailed description on antennas, please refer to "The ARRL Antenna Hand Book" or "The Radio Amateur Hand Book".

It is recommended to use the transmitting antenna when the FR-101 is used with a transmitter or a transceiver. Antenna change-over is accomplished by an antenna relay provided in our transmitter or transceiver.

The FR-101 should be connected to a good ground. The ground lead should be connected to the terminal marked GND located on the rear panel of the receiver.

SPEAKER

A 4 ohm speaker should be connected to the jack on the rear of the chassis marked SP. One lead of the speaker output is grounded to the chassis so that the one lead of the speaker should be connected as illustrated in Figure 2. Our accessory speaker model SP-101B/277B or SP-101PB/277PB provides the correct impedance match and matches in appearance with the FR-101.

HEADPHONE (4 to 8 ohm impedance)

A headphone jack is provided on the front panel for the use of a high sensitivity headphone. When a low sensitivity headphone is used, the 100 ohm resistor, R11, should be shorted for adequate volume. (Ref. to Fig. 1)

MUTE

The MUTE jack on the rear of the chassis is wired so that the receiver will operate only when the inner-conductor of this jack is shorted to ground. When the FR-101 is operated separately, and external muting is not desired, the RCA plug with shorted inner and outer conductors should be inserted into the MUTE jack. The inner-conductor should, therefore, be connected to a relay contact in the transmitter, or the transceiver, which is normally open in transmit and grounded in receive. It is recommended that a shielded wire be used for the interconnection between the transmitter or transceiver.

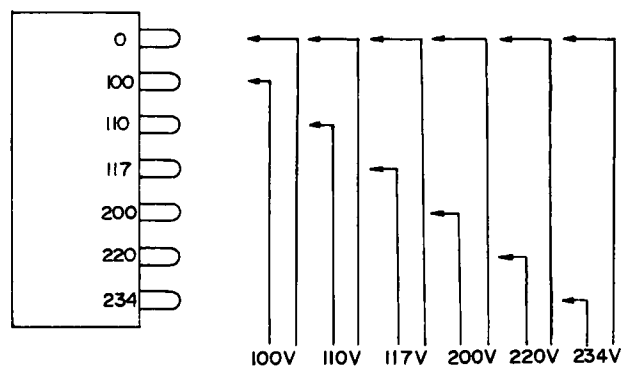

POWER TRANSFORMER PRIMARY CONNECTIONS

CONTROLS AND SWITCHES

The FR-101 has been specifically designed for ease of operation and versatility. All controls have been properly adjusted at the factory. Several panel controls and switches are unusual in operation, and improper adjustment may result in poor receiver performance. The

function of various controls and switches is described in the following section. Be certain that you understand thoroughly the individual function of each before operating the receiver.

FRONT PANEL

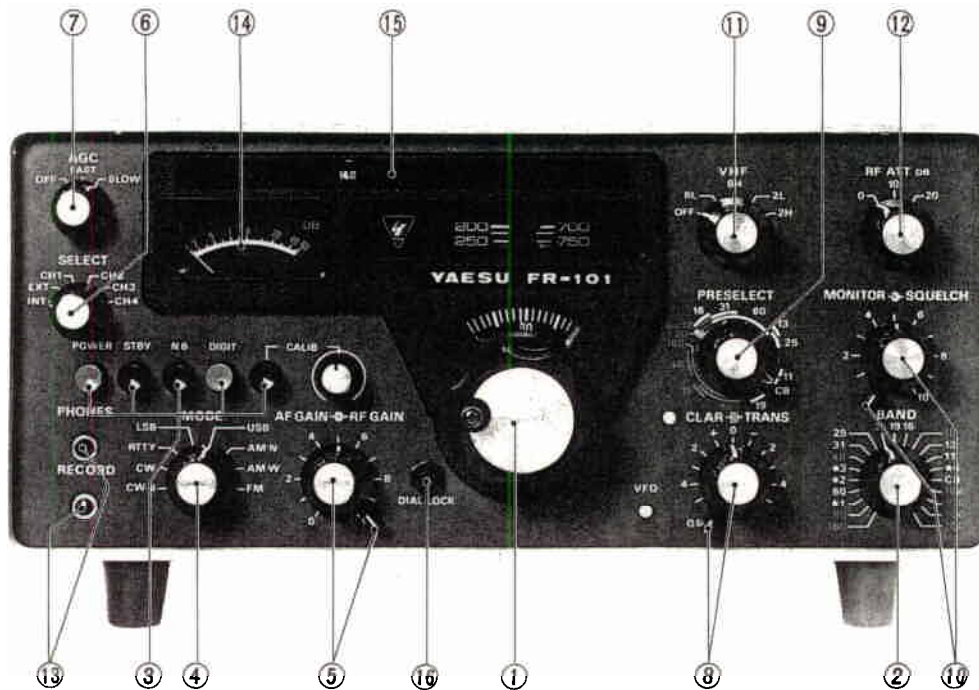

(1) MAIN TUNING

The MAIN TUNING knob determines the frequency which you are receiving.

(2) BAND

The BAND switch is a twenty one position switch. The tunable frequency range of each band is listed in the specifications on page 2.

(3) FUNCTION SWITCH

The FUNCTION switch consists of five push button switches: POWER, STBY, NB, DIGIT and CALIB.

POWER: When this switch is in the depressed position, the power transformer primary is connected to the power line for AC operation. A separate DC cable is provided for connection to a battery for DC operation.

STBY: With this switch in the depressed position, the receiver is muted.

NB: With this switch in the depressed position, the Noise Blanker is activated.

DIGIT: This switch is used on the digital readout receiver to turn off the last digit if the flicker is annoying.

CALIB: With this switch in the depressed position, the 100 KHz/25 KHz calibrator is switched on.

A control is used for the calibration of the digital model only.

(4) MODE

The MODE switch is an eight position switch which determines the appropriate detector and the filter in use. In the AM position, a diode detector is incorporated and the carrier oscillator is switched off. In the CW, RTTY, and SSB (USB & LSB) positions, a ring demodulator is used as a detector with the appropriate carrier oscillator turned on. In the FM position, an (optional) FM detector unit is switched in. The appropriate filter is also automatically selected by the MODE switch.

(5) AF-RF GAIN

The AF and RF GAIN control is a concentric double-shaft potentiometer. The inner knob controls the audio output level of the receiver and the outer lever knob controls the RF and IF gain of the receiver.

(6) SELECT

This switch provides the selection of an external VFO or one of four crystal-controlled oscillator positions. Normal operation of the FR-101 requires that the switch be placed in the "INT" (Internal) position. When the switch is in the "INT" position, a red lamp marked VFO is lighted.

(7) AGC

This switch selects the AGC time constant. In the SLOW position, the AGC time constant is 0.75 second and in the FAST position, it is approximately 0.025 second. In the OFF position, AGC voltage is not generated. The SLOW position is normally used with SSB and CW, and the FAST position is normally used for break-in CW and RTTY. The OFF position may be used on CW under difficult reception conditions in conjunction with the RF Gain control

(8) CLAR-TRANS

These controls use a concentric double-shaft potentiometer. The CLAR (Clarifier) control - the inner knob - provides a means of varying the receiver frequency a few KHz to either side of the transmitting frequency when the FR-101 is used as a companion receiver to the FL-101 or FT-101E/277E. Thus it is possible to set the pitch of the voice you are receiving to the most readable point without affecting your transmitting frequency. The CLAR control may be switched off and the receiver locked to the transmitting frequency by setting the CLAR control to the OFF position. Normally, you will want to keep the clarifier in the OFF position until the initial contact is made. The CLAR control may then be used to zero-in and correct any drift on the received signal. With the clarifier ON position, a red lamp is lighted.

The TRANS (Transceiver) control is used to coincide the receiving frequency with transmitting frequency when the FR-101 is used in conjunction with the FL-101 or

FT-101E/277E. Slowly advance the MONITOR knob of the FR-101 to monitor the transmitted signal, then adjust the TRANS control for the most natural voice quality while transmitting.

(9) PRESELECTOR

The PRESELECTOR control permeability-tunes the antenna and RF coils in the receiver front-end. The scale on this control is calibrated with the wave length markings showing the correct setting for various bands. This control has two pointers - red and white. The red pointer corresponds to red band markings and the white pointer to white band markings.

(10) MONITOR-SQUELCH

The MONITOR control is used to monitor the transmitted signal when the FR-101 is used in transceive with the FL-101 transmitter or FT-101E/277E transceiver. The SQUELCH control adjusts the receiver squelch threshold sensitivity in the FM reception mode (when the optional FM detector unit is installed).

(11) VHF

The VHF switch selects the (optional) 6 meter and 2 meter VHF convertors. In normal reception, this switch should be set to the HF position.

(12) RF ATT

The RF ATT (RF Attenuator) switch attenuates the incoming signal to prevent over-loading of the front-end when an extremely strong signal is present.

(13) PHONE-RECORD

PHONE and RECORD jacks are provided for private listening and recording when desired. The attenuator resistor, R11, is connected to the PHONE jack in order to use high sensitivity stereo headphones.

(14) S-METER

The S-METER indicates the relative signal strength of a received signal. It is calibrated in S-Units from S-1 to S-9 and in DB over S-9.

(15) BAND INDICATOR

The BAND INDICATOR automatically indicates the band in use when the BAND switch is set to the desired band.

(16) DIAL LOCK

The DIAL LOCK locks the dial for the dial calibration.



Fig. 1

REAR PANEL CONNECTIONS

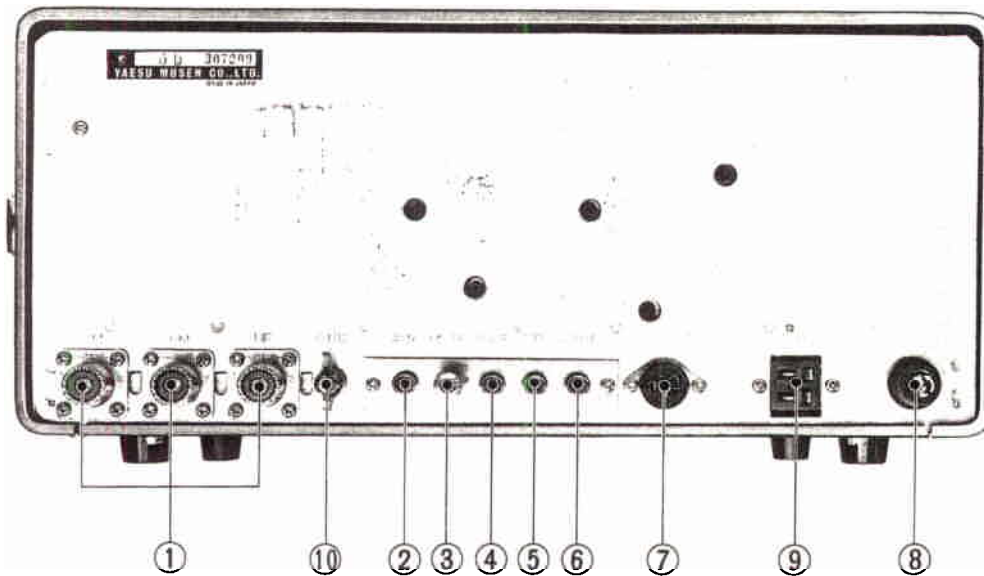

(1) ANTENNA CONNECTOR

Three coaxial connectors are provided for separate use on HF, 6 meter and 2 meter bands. The input impedance is approximately 50 ohms and an antenna having an impedance between 50 to 75 ohms should be used.

(2) AUX JACK

An AUXILIARY jack is provided for optional use and this jack is not wired internally.

(3) MUTE JACK

The MUTE jack is for externally muting the receiver. Shorting the center conductor to ground places the receiver in the receive mode and the FR-101 mutes when the center conductor is open from ground.

(4) TONE JACK

The TONE jack is for input of an external sidetone signal in CW operation.

(5) SP JACK

The SP jack is for a connection of 4 ohm speaker, such as our SP-101B/277B.

(6) A. TRIP

The receiver audio signal is brought out from the A. TRIP (Anti-Trip) jack for use in energizing the VOX circuit of a transmitter used with the FR-101, such as our FL-101 or FT-101E/277E.

(7) VFO

This socket is used for coupling the VFO signal of FR-101 to the FL-101 or FT-101E/277E, so that transceive operation may be obtained.

(8) FUSE

A 1 amp. fuse is used to protect the FR-101. For 220 volt operation, a 0.5 amp. fuse should be used.

(9) POWER

The POWER socket accepts AC or DC voltages. AC and DC cables are provided.

(10) GND

This is for a GROUND connection.

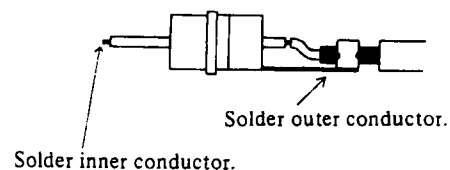

Fig. 2

OPERATION

The receiving procedure of the FR-101 is not complicated, however care should be exercised when tuning to insure optimum performance of the equipment. The following paragraphs describe the procedures for the operation of the receiver.

INITIAL CHECK

Before connecting the FR-101 to a power source, carefully examine for any visible damage. Check that all modules and crystals are firmly in their sockets and that controls and switches are operating normally. Be sure that the voltage specification marked on the rear panel matches the supply voltage.

FREQUENCY SELECTION

The main tuning dial has two scales for proper frequency readout and is marked in 50 KHz increments to provide a coarse setting within a given band. The white scale is for 0 to 500 KHz and a green scale is for 500 KHz to 1 MHz. The sub-dial in window is marked in 1 KHz increments and provides accurate settings of the received frequency.

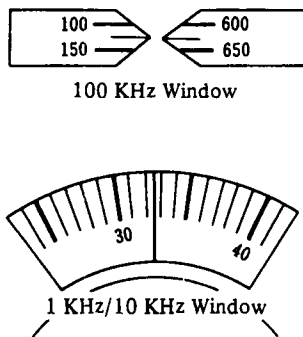

Fig. 3

The lower frequency limit of the main tuning dial is automatically illuminated in the top window of the dial escutcheon by setting the BAND switch. For example, when the BAND switch is set to 25 meter band, the top window shows 11.5 MHz as starting frequency. Therefore, the green scale is used for the frequency readout. The setting shown in the example, Figure 3, would then be 11,632.5 KHz, when the BAND switch is set to 25 meter band. When the BAND switch is set to 20 meter band, then the starting frequency is now 14.0 MHz. Therefore, the above setting would then be 14,132.5 KHz. The amateur bands are marked in red on the BAND switch. For VHF reception (with the optional convertors), the 10 meter bands are used as a variable IF stage. Refer to the Table 1 for the correct frequency readout.

BAND	HF (MHz)	6L (MHz)	6H (MHz)	2L (MHz)	2H (MHz)
10A	28.0	50.0	52.0	144.0	146.0
	28.5	50.5	52.5	144.5	146.5
10B	28.5	50.5	52.5	144.5	146.5
	29.0	51.0	53.0	145.0	147.0
10C	29.0	51.0	53.0	145.0	147.0
	29.5	51.5	53.5	145.5	147.5
10D	29.5	51.5	53.5	145.5	147.5
	30.0	52.0	54.0	146.0	148.0

Table 1

PRELIMINARY CONTROL SETTING

For all modes of operation, set the controls as follows:

POWER	OFF (push out position)
AGC	SLOW (push out position)
SELECT	INT
STBY	OFF (push out position)
NB	OFF (push out position)
DIGIT	OFF (push out position)
CALIB	OFF (push out position)
MODE	Desired mode
AF GAIN	Comfortable listening level
RF GAIN	Fully clockwise
VHF	HF
RF ATT	0
MONITOR	Fully counter-clockwise
SQUELCH	Fully counter-clockwise
CLAR	OFF
TRANS	Fully counter-clockwise
BAND	Desired band
PRESELECT	Set the band mark and peak for maximum S-meter reading.

Push in the POWER switch and tune the main tuning dial for the desired signal and peak the PRESELECTOR for a maximum S-meter reading. The bandwidth of the receiver is automatically selected by the setting of the MODE switch as listed in Table 2.

If impulse type noise is experienced, push in the NB (Noise Blanker) switch. The noise blanker is an IF device which turns off the signal pass during a noise pulse. It is equally effective on all modes except the FM mode, however it will be noticed that the noise blanker works when the noise is greater than the desired signal. Due to the effect of the AGC in holding the audio output constant the noise may not appear to decrease, but a signal down in the noise will come up. It should be noted that the noise blanker functions best on noise pulses which are very short in duration and which are separated widely in time such as automobile ignition noise. For continuous noise, such as power line static,

the noise blanker will be less effective since the blanker circuit has difficulty in distinguishing the noise from the desired signal.

For VHF reception, set the VHF switch to the desired band, either 6 or 2 meters. Set the BAND switch to the 10 meter band and peak the PRESELECTOR for maximum S-meter reading. The frequency relation is listed in Table 1. When the (optional) FM unit is installed, advance the SQUELCH control slowly until the back-ground noise disappears with no signal input.

MODE	BANDWIDTH	
	CW-N *	0.6 kHz/6 dB
CW		
RTTY**		
LSB	2.4 kHz/6 dB	4.0 kHz/60 dB
USB		
AM-N		
AM-W *	6 kHz/6 dB	12 kHz/50 dB
FM *	20 kHz/6 dB	45 kHz/50 dB

*With optional filter for FR-101 Standard type receiver

**With optional filter for FR-101 Standard and Deluxe type receivers.

Table 2

DIAL CALIBRATION

The calibration of the main tuning dial may vary slightly from band to band due to the tolerance limits of the heterodyne crystals. Therefore, a dial calibration knob is provided on the front panel. To set the calibration on a given band and desired mode, proceed as follows:

1. Set the BAND switch and the PRESELECTOR to the desired band.
2. Set the CLAR switch to OFF position.
3. Push the CALIB switch in. A switch is located on the top of AF unit inside the cabinet that selects either the 25 KHz or 100 KHz calibrate signals. When the switch is set in the direction of front panel, a calibrate signal may be heard at 25 KHz intervals.
4. Set the 100 KHz dial in the window to the nearest 100 KHz or 25 KHz reading, then zero beat the main tuning dial against marker signal while pressing the DIAL LOCK. For AM or FM, the beat tone can not be heard. Therefore, the calibration should be made for maximum S-meter reading. Since the AM and FM filters have a wide bandwidth, the calibration should be made at the center of the passband as illustrated in Figure 4.

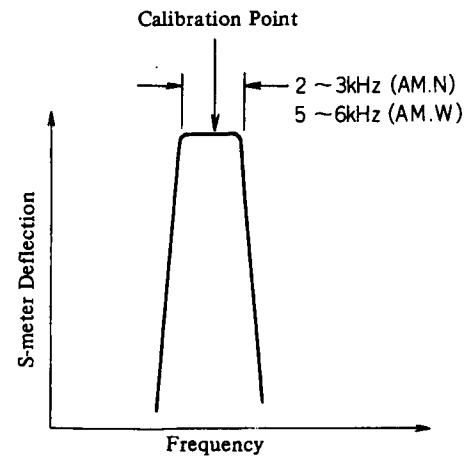

Fig. 4

CRYSTAL-CONTROLLED SPOT RECEPTION

The FR-101 provides for spot frequency reception with a crystal-controlled oscillator utilized in the place of the main tuning VFO. The crystal holders accept standard HC-25/U type crystals. All crystal frequencies must fall between 8,700 to 9,200 KHz. A trimmer capacitor has been connected to each crystal for precise frequency adjustment and its adjustment range is approximately 1 KHz. The correct crystal frequency for any desired operating frequency within the band set by the BAND switch, may be determined as follows:

$$F \text{ crystal} = f_1 - F_x$$

Where f_1 is taken from Table 3; F_x is the last 3 figures of operating frequency from which Mega-Hertz order is disregarded. When the last 3 figures are between 500 to 999 KHz, 500 KHz is subtracted from this value.

- Example 1—Find the crystal frequency for 7099 KHz in LSB mode.

From the Table 3, f_1 is 9201.5 KHz.

Therefore, F crystal is $9201.5 - 99 = 9102.5$ KHz.

- Example 2—Find 11.750 MHz AM reception.

From the Table 3, f_1 is 9200 KHz.

Therefore, F crystal is $9200 - (750 - 500) = 8950$ KHz.

MODE	f_1 (KHz)
AM, FM	9200.0
LSB	9201.5
USB	9198.5
CW	9199.3

Table 3

AUXILIARY BAND RECEPTION

In addition to the amateur and major shortwave broadcast bands, the FR-101 may be programmed to receive four 500 KHz-wide ranges covered in Table 4.

The crystals can be ordered direct from your dealer. When ordering, be sure to specify that the crystals you desire are for auxiliary band use in the FR-101.

The PRESELECTOR tuning range is given in Figure 5. On ☆1, ☆2 and ☆4 position, the FR-101 will work properly by only inserting the crystals, however on ☆3 position, TC22 must be adjusted as follows:

1. Insert the crystal in ☆3 socket.
2. Set the BAND switch to ☆3 position.
3. Push the CALIB switch on and tune the FR-101 to

the calibrator signal.
4. Peak the PRESELECTOR.

5. Adjust TC22 for maximum S-meter reading.

Insert the crystal of the correct frequency given in the Table 4 to the corresponding crystal socket located on the right side of the chassis. The crystal socket accepts standard HC-25/U type crystals. In order to receive the desired band, the BAND switch must be set to the number corresponding to the crystal socket in which the auxiliary crystal in use is installed.

A fundamental frequency is used when the crystal frequency is lower than 28 MHz and the second harmonic when higher than 28 MHz. It should be noted that the bands covered in Table 4 work only when the appropriate auxiliary bands are used as listed in the Table.

AUX	FREQ (MHz)	LOCAL OSC		RF AMP		MIX T103
		XTAL (MHz)	TRIMMER	T101	T102	
☆1	4.0~4.5	10.02	TC25 + C38	T107 + C4	T108 + C7	T109 + C20
☆2	5.0~5.2	11.02	TC24 + C37	T107 + TC1 + C9	T108 + TC2 + C11	T109 + TC11 + C22
☆3	7.5~8.0	13.52	TC22 + 50P	TC3 + C12	TC4 + C14	TC11 + C23
	8.0~8.5	14.02	"	"	"	"
	8.5~9.0	14.52	"	"	"	"
☆4	22.0~22.5	28.02	C44	TC9	TC10	TC15
	22.5~23.0	28.52	"	"	"	"
	23.0~23.5	29.02	"	"	"	"
	23.5~24.0	29.52	"	"	"	"
	24.0~24.5	30.02	"	"	"	"
	24.5~25.0	30.52	"	"	"	"
	25.0~25.5	31.02	"	"	"	"
	26.0~26.5	32.02	"	"	"	"
	26.5~27.0	32.52	"	"	"	"
27.5~28.0	33.52	"	"	"	"	

Table 4 AUX BAND

The band not covered by Table 4 may be programmed by using the band which is already assigned to another band. The relations between the desired new band and existing band are listed in Table 5.

○ Example—Desired Band: 10.5 - 11.0 MHz

From the Table 5, the local crystal frequency is 16.52 MHz.

Insert this crystal into the crystal socket assigned to the 31 meter band as shown in the remarks column of Table 5. Adjust TC21 as described in ☆3 band adjustment. Set the BAND switch to the 31 meter band position and peak the PRESELECTOR around the scale given in Figure 5.

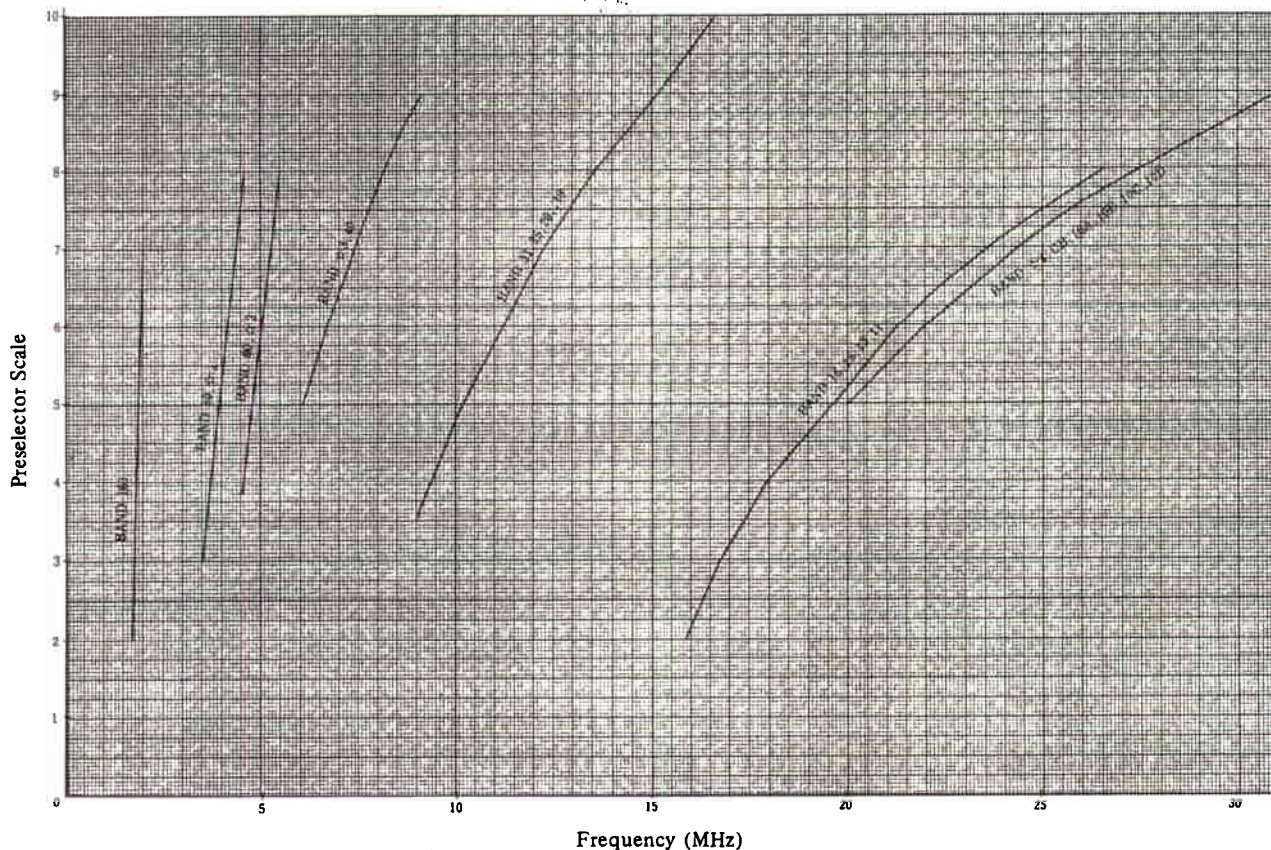

Fig. 5

FREQ	XTAL (MHz)	BAND	RMKS	FREQ	XTAL (MHz)	BAND	RMKS	
1.8~2.0	7.52	160		16.0~16.5	22.02		Use 16m band.	
2.0~2.5			Not covered.	16.5~17.0	22.52			
2.5~3.0				17.0~17.5	23.02			
3.0~3.5				17.5~18.0	23.52	16		
3.5~4.0	9.52	80		18.0~18.5	24.02			
4.0~4.5	10.02		AUX 1	18.5~19.0	24.52			Adjust TC18.
4.5~5.0	10.52	60		19.0~19.5	25.02			
5.0~5.2	11.02		AUX 2	19.5~20.0	25.52			
5.5~6.0			Not covered.	20.0~20.5	26.02			
6.0~6.5				20.5~21.0	26.52			
6.5~7.0				21.0~21.5	27.02	15		
7.0~7.5	13.02	40		21.5~22.0	27.52	13	AUX 4	
7.5~8.0	13.52		AUX 3	22.0~22.5	28.02			
8.0~8.5	14.02			22.5~23.0	28.52			
8.5~9.0	14.52			23.0~23.5	29.02			
9.0~9.5	15.02		Use 31m band.	23.5~24.0	29.52			
9.5~10.0	15.52	31		24.0~24.5	30.02			
10.0~10.5	16.02		Adjust TC21.	24.5~25.0	30.52			
10.5~11.0	16.52			25.0~25.5	31.02			
11.0~11.5	17.02		Use 25m band.	25.5~26.0	31.52	11		
11.5~12.0	17.52	25		26.0~26.5	32.02			
12.0~12.5	18.02		Adjust TC20.	26.5~27.0	32.52			
12.5~13.0	18.52			27.0~27.5	33.02	CB		
13.0~13.5	19.02		Use 20m or 19m band.	27.5~28.0	33.52			
13.5~14.0	19.52			28.0~28.5	34.02	10A		
14.0~14.5	20.02	20	Adjust TC19 or TC27.	28.5~29.0	34.52	10B		
14.5~15.0	20.52			29.0~29.5	35.02	10C		
15.0~15.5	21.02	19		29.5~30.0	35.52	10D		
15.5~16.0	21.52							

Table 5

TRANSCEIVE OPERATION

The FR-101 has the feature of transceive operation when it is used with our FL-101 transmitter or FT-101E/277E transceiver.

(1) FR-101-FL-101 COMBINATION

Before connecting the equipment, the interconnection cables should be prepared as illustrated in Figure 9. Install the FL-101 side by side with the FR-101 and connect them, as illustrated in Figure 6, with the cables prepared.

The switches and controls may be used as described in the preceding pages, however some of them are used particularly in transceive operation as follows:

SELECT: This switch selects the VFO (main tuning) of both transmitter and receiver as shown in Table 6. The red lamp will light up to indicate the VFO in use.

MONITOR: When the transmitting frequency coincides with the receiving frequency, the transmitted signal may be monitored by advancing this control slowly in a clockwise

TRANS:
(Transceive)

direction. When the monitored signal is distorted by overloading, use the RF ATTENUATOR. This control does not work for CW sidetone monitoring, since the CW sidetone must be set to the desired listening level with the controls in the transmitter section.

This control is used to coincide the frequency difference between the FR-101 and transmitter due to the tolerance limits of the various crystals. The adjustment of this control is as follows:

Set the CLAR control to OFF position. Advance the MONITOR control until your transmitting voice is heard from the FR-101 while transmitting on the same SSB mode as that of the receiver. Adjust the TRANS control for a natural voice quality. For CW operation, adjust the TRANS control for maximum S-meter reading of the monitor signal with the mode switch in the CW Narrow position, while keying the transmitter. Once the above adjustment has been done, it is not necessary to readjust the control until the band or mode in use is changed.

	SELECT SWITCH		OPERATION
	FR-101	FL-101	
1	INT	INT	Separate operation.
2	EXT	INT	Transmitter VFO controls transmitter and receiver.
3	EXT	EXT	Transmitter VFO controls receiver, and receiver VFO controls transmitter frequency.
4	EXT	TRX	Receiver VFO controls transmitter and receiver. (Transceive operation by FR-101's VFO.)

Table 6

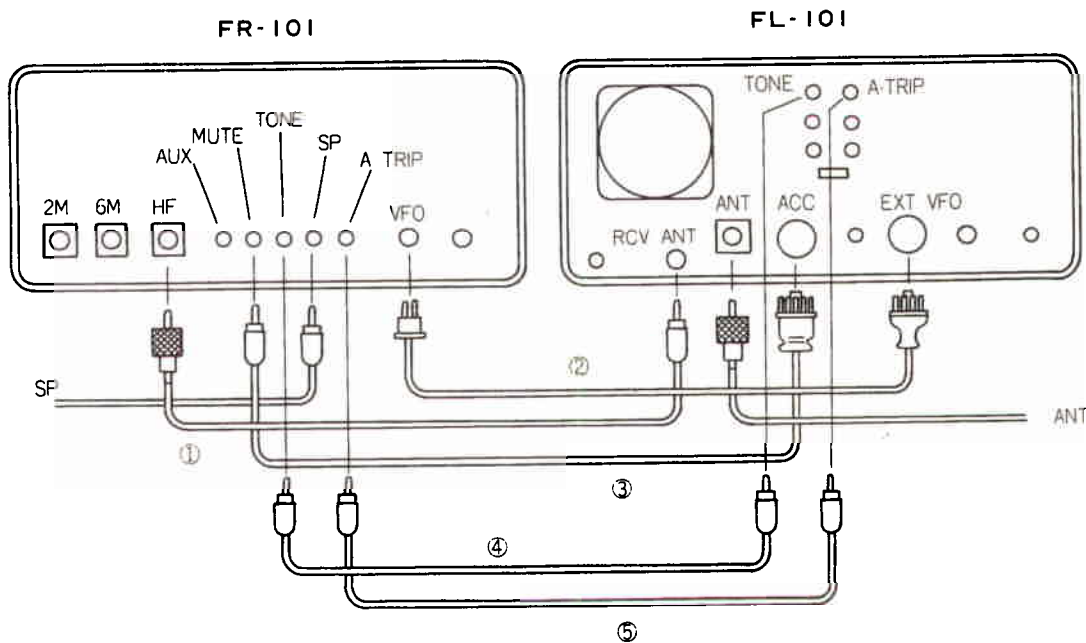

Fig. 6

(2) FR-101-FT-101E/277E COMBINATION

Connect the FR-101 and FT-101E/277E as illustrated in Figure 7. The operation is exactly same as the FR-FL combination except the function of SELECT switch, which is shown in Table 7.

Since the first IF of FR-101 has the characteristics shown in Figure 8, the receiver sensitivity will be decreased by the same amount shown on the Figure 8 when the FR-101 and FT-101E/277E are operated on different frequencies in mode 4 of Table 7.

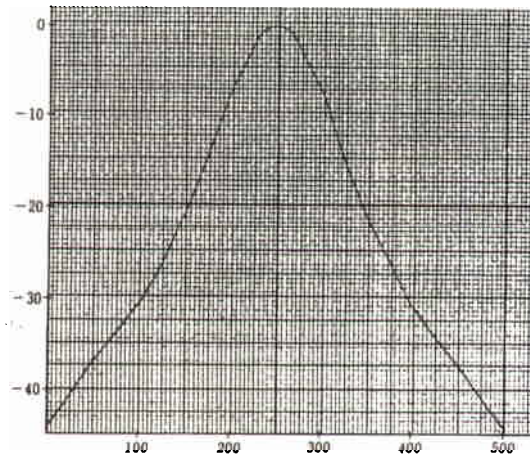

Fig. 8

	SELECT SWITCH		OPERATION
	FR-101	FT-101E/ 277E	
1	INT	INT	Separate operation. Transceiver VFO controls transceiver, and receiver VFO controls receiver.
2	EXT	INT	Transceiver VFO controls transceiver and receiver. (Transceive operation by FT-101E/277E's VFO)
3	EXT	RXEXT	Transceiver VFO controls transmitting frequency. Receiver VFO controls receiver itself and receiving frequency of transceiver.
4	EXT	TXEXT	Transceiver VFO controls receiving frequency of transceiver and receiver. Receiver VFO controls transmitting frequency of transceiver.
5	EXT	EXT	Receiver VFO controls both transceiver and receiver.

Table 7

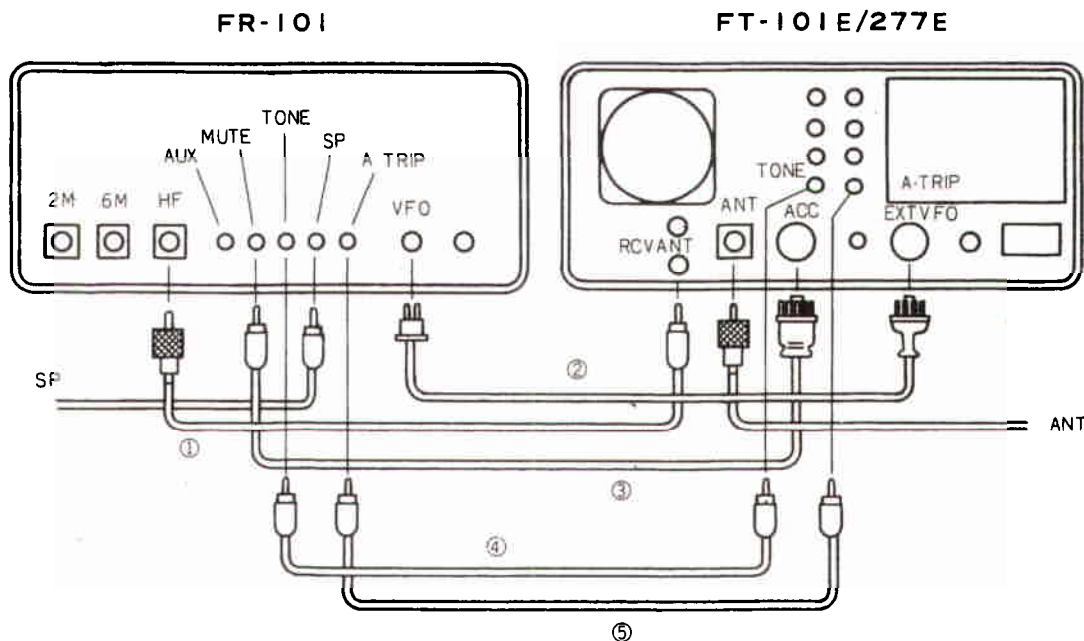

Fig. 7

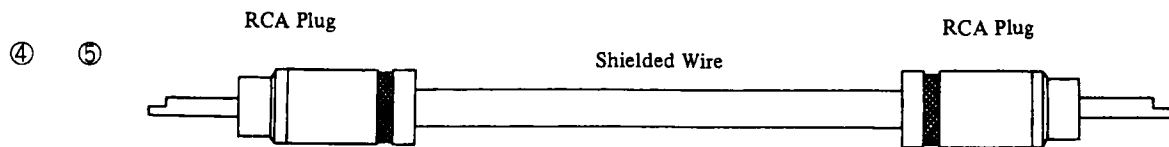
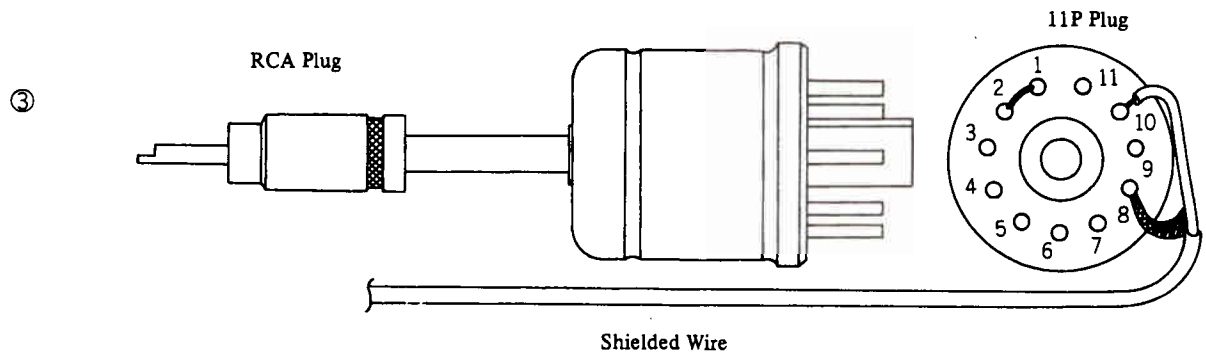
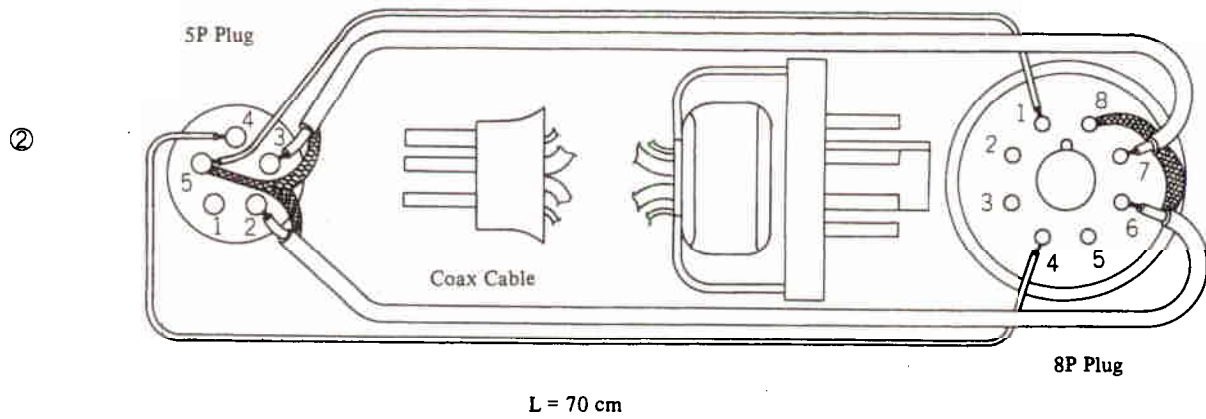
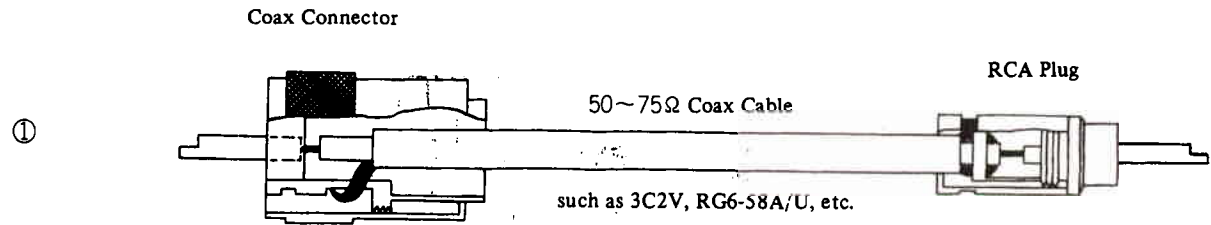

Fig. 9

CIRCUIT DESCRIPTION

The block diagram will provide you with the better understanding of this receiver. The FR-101 uses extensively, computer type, plug-in modules for reliable performance and ease of maintenance. These modules are: Noise Blanker/Mixer Unit, IF Unit, Audio Calibra-

tor Unit, BFO/Regulator Unit, and (optional) VHF Converter Units. The RF Unit is assembled in the BAND switch/PRESELECTOR combination board on the chassis.

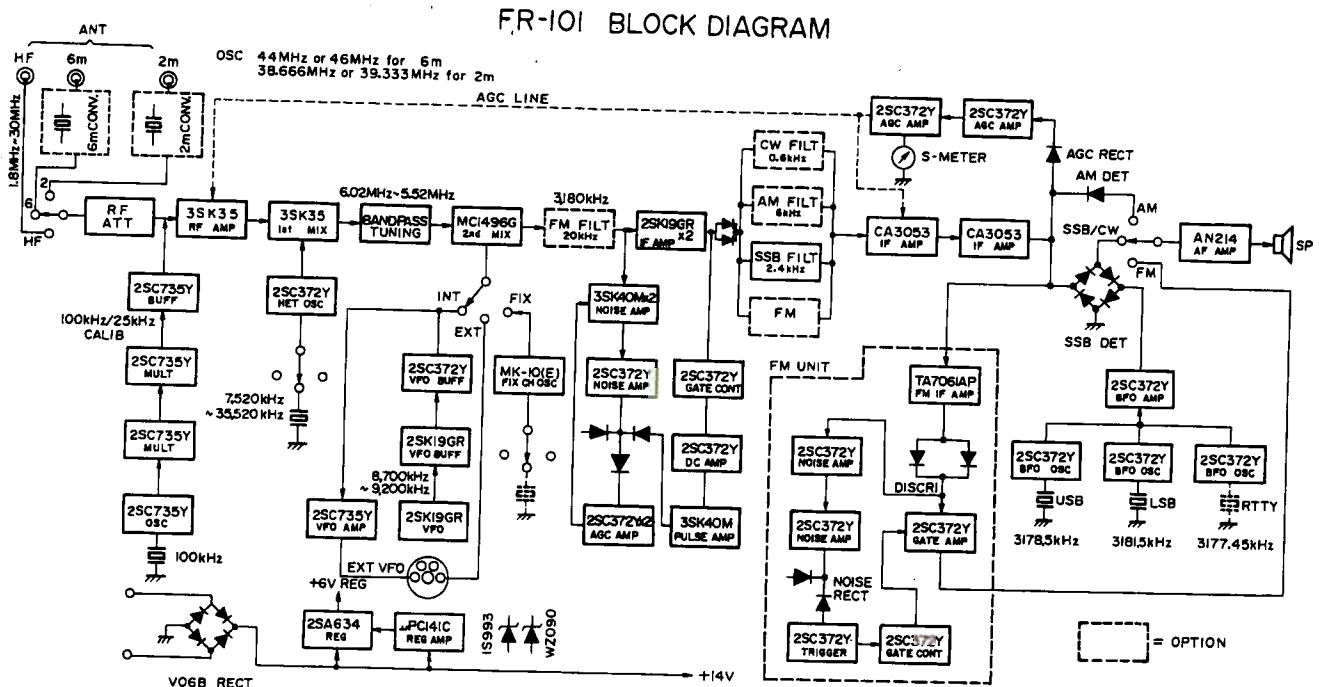

Fig. 10

SIGNAL FLOW

The signal from the antenna is fed to an antenna coil through the IF trap coil, RF attenuator and VHF/HF selector switch. The antenna coils consist of two permeability tuned coils, T101 and T102. The T104, T105, T107 and T108 are connected in series with T101 and T102 by the BAND switch in order to obtain a proper L/C ratio on lower bands. The signal is then fed to the gate of the FET RF amplifier, Q1, 3SK35. The amplified signal is then coupled through T103 to the first mixer, Q2, 3SK35, where the incoming signal is mixed with a signal from the heterodyne oscillator, Q1, 2SC372Y. T106 and T109 are connected in series with T103 to increase the inductance of T103 at lower band settings of the BAND switch. The relation between the coils and tuning capacitors in RF tuning circuit is shown in Table 8.

The product of the first mixer becomes first IF signal of 5,520 through 6,020 KHz. The first mixer converts the incoming signal to the first IF signal which is applied to the second mixer, Q1, MC1496G, through the tunable first IF transformers formed by T111, T112, and T113. The variable capacitor in the VFO unit is ganged to the tuning capacitor, VC1, in the first IF stage, by means of

a mechanical gear assembly. The tuning of the first IF stages provides sharp selectivity. The second mixer, Q1, MC1496G, converts the first IF signal into a second IF signal of 3,180 KHz in a balanced mixer configuration which greatly reduces spurious responses. The VFO signal, which varies between 8,700 and 9,200 KHz, is generated by Q1, 2SK19GR, amplified by Q2, 2SK19GR, and supplied to the second mixer through the buffer amplifier, Q3, 2SC372Y. The VFO output signal is fed to the EXT VFO jack through the SELECT switch and the buffer amplifier, Q1, 2SC375Y, for transceiver operation with the accompanying transmitter or transceiver.

The output signal from the second mixer is fed through T114 to a first crystal filter, XF30D, which is tuned to the second IF frequency and has ± 10 KHz passband response to eliminate interference. The signal is then amplified by the second IF amplifier, Q5 and Q8, 2SK19GR, and fed to the IF unit from pin 18 through T117. D8 through D15, 1S1007, are diode switches which automatically select the appropriate crystal filter for the mode in use. The voltage for the diode switches is controlled by the MODE switch. The signal from the

crystal filter is amplified through Q4 and Q5, CA3053, and fed to the appropriate detector.

The ring demodulator, D1 through D4, 1S1007, is used for the detection of SSB, CW, and RTTY signals. The carrier signal for SSB and the beat frequency signal for CW and RTTY, which is generated by the carrier oscillator Q1, Q2, and Q3, 2SC372Y, in the Regulator and BFO Unit, is fed to the ring demodulator through a buffer amplifier, Q1, 2SC372Y. The ring demodulator is balanced by VR1 for minimum distortion. The carrier oscillator oscillates either at 3,177.45 KHz, 3,181.50 KHz or 3,178.50 KHz, depending upon whether Q1, Q2 or Q3, 2SC372Y, is selected by the MODE switch. The MODE switch disconnects the emitter circuit of either transistor when not in use. The relation between the mode of received signal and carrier frequency is shown on Table 9.

MODE	FILTER	XTAL
CW-N	XF-3	X-3
CW	XF-1	X-3
RTTY	XF-1	X-1
USB	XF-1	X-3
LSB	XF-1	X-2
AM-N	XF-1	-
AM-W	XF-2	-
FM	-	-

X-1 = 3177.45 KHz.

X-2 = 3181.5 KHz.

X-3 = 3178.5 KHz.

Table 9

BAND	FREQ (MHz)	LOCAL OSC		RF AMP		MIXER T103
		XTAL (MHz)	TRIMMER	T101	T102	
160	1.8~2.0	7.52	TC26+C39	T104+C1	T105+C3	T106+C19
80	3.5~4.0	9.52	TC25+C38	T107+C4	T108+C7	T109+C20
60	4.5~5.0	10.52	TC24+C37	T107+TC1+C9	T108+TC2+C11	T109+TC11+C20
40	7.0~7.5	13.02	TC23+C36	TC3+C12	TC4+C14	TC12+C23
31	9.5~10.0	15.52	TC21+C35	TC5+C15	TC6+C17	TC13+C24
25	11.5~12.0	17.52	TC20+C34	"	"	"
20	14.0~14.5	20.02	TC19+C33	"	"	"
19	15.0~15.5	21.02	TC27+C42	"	"	"
16	17.5~18.0	23.52	TC18+C32	TC7	TC8	TC14
15	21.0~21.5	27.02	TC17	"	"	"
13	21.5~22.0	27.52	"	"	"	"
11	25.5~26.0	31.52	C44	"	"	"
CB	27.0~27.5	33.02	"	TC9	TC10	TC15
10A	28.0~28.5	34.02	"	"	"	"
10B	28.5~29.0	34.52	"	"	"	"
10C	29.0~29.5	35.02	"	"	"	"
10D	29.5~30.0	35.52	"	"	"	"

Table 8

An AM signal is detected by D5, 1S1007. An FM signal is fed to a limiter amplifier, Q6, TA7061AP, in an (optional) FM detector unit through C13 and Pin 1. The output from Q6 is then fed to the FM detector consisting of D1 and D2, 1S188FM. The detected audio signal is amplified by Q1, 2SC372Y, and fed to the audio amplifier unit through the MODE switch. The squelch circuit consists of a noise amplifier, Q4 and Q5, 2SC372Y, a rectifier, D3 and D4, 1S188FM, and Schmitz trigger circuit, Q2 and Q3, 2SC372Y. The noise produced at the output of the FM detector is amplified by noise amplifier, Q4 and Q5, which is tuned to

approximately 35 KHz and rectified by D1 and D2. The rectified DC voltage is fed to the Schmitz circuit through the SQUELCH threshold control on the front panel. The Schmitz circuit cuts off the audio amplifier, Q1, in the absence of an incoming RF carrier, and thus speaker noise is eliminated. The audio output signals from the detectors are fed to the audio amplifier integrated circuit, Q5, AN214, through the MODE switch and the AF GAIN potentiometer. The audio amplifier circuit utilizes a OTL (Output Transformer-Less) circuit and delivers 3 watts to the speaker.

AGC & S-METER CIRCUIT

The output signal from the last IF amplifier, Q4, is fed to the AGC (Automatic Gain Control) rectifiers, D6 and D7, 1S1555, through C14. The rectified AGC voltage is then amplified by a DC amplifier, Q2 and Q3, 2SC372Y. The AGC voltage automatically controls the gain of the RF amplifier, Q1, 3SK39Q, the second IF amplifier, Q5, CA3053, and the (optional) VHF converters. The S-meter is placed in the emitter circuit of the AGC amplifier, Q3, in which the emitter current changes in accordance with the signal strength.

NOISE BLANKER CIRCUIT

The second IF signal is fed through T114 and a crystal filter XF1 to the amplifier Q3 and Q4, 2SK19GR. The amplified signal is then fed through the noise blanker gate diodes D1 and D2, 1S188 FM to the IF unit.

A portion of the input signal is fed through C22 to the noise amplifier Q5, Q6, 2SK40M and Q7, 2SC372Y. The amplified signal is rectified by the diodes D3 and D4, 1S188 FM to produce a reference bias voltage for the noise blanker.

This DC voltage is amplified by the DC amplifier Q11 and Q12, 2SC372Y and used to the AGC voltage for Q5 and Q6.

The output from Q6 is fed to a noise detector diode D5, 1S188 FM. The bias voltage obtained by D3 and D4 is applied to D5.

D5 is so biased by the reference bias voltage that it does not conduct with a normal signal but conducts with the pulse noise which exceeds signal level.

As a result, a pulse amplifier Q8, 3SK40M conducts for a normal signal, causing inverter Q9, 2SC372Y cutoff. In turn, gate controller Q10, 2SC372Y conducts.

Thus, noise gate diodes D1 and D2, 1S188 FM conduct and the signal passes these diodes. When noise pulse

exists, the bias obtained from D5 turns Q8 into cutoff, in turn, Q9 conducts and Q10 stops to conduct and D1, D2 is biased to cutoff preventing the signal passing from the diodes.

FIX CHANNEL CIRCUIT

A FET, Q1, 2SK19GR, crystal-controlled oscillator, produces the second mixer injection signal. Four crystals may be selected by the SELECT switch on the front panel. The output signal is fed to the second mixer through L101. The clarifier control on the front panel varies the voltage on a varicap diode, D1, 1S2236, resulting in a slight change of oscillating frequency to compensate for crystal frequency tolerance.

POWER SUPPLY & VOLTAGE REGULATOR CIRCUIT

The power supply is designed to operate from either 100/110/117/200/220/234 volt AC 50/60 Hz or 12 volt DC (negative ground). Inserting the appropriate power plug into the rear panel receptacle makes the necessary connection to operate the supply in either AC or DC. For AC operation, +14.5 volts is supplied from bridge connected rectifier diodes, D2 through D5. The DC voltage from this rectifier is supplied to the voltage regulator, Q4 μ PC141C, Q5, 2SA634 to obtain an extremely stable 6 volt DC supply which is then fed to the various circuits. The digital readout receiver is designed for AC operation only.

CALIBRATOR CIRCUIT

Crystal-controlled oscillator, Q1, 2SC735Y, on the AF board, oscillates at 100 KHz for calibration purpose. A trimmer capacitor, TC1, is used to calibrate 100 KHz crystal frequency against WWV or JJY. The output from this oscillator is fed into a 25 KHz multivibrator, Q2 and Q3, 2SC735Y, which generates a marker signal every 25 KHz. The switch on the printed board disables the 25 KHz multivibrator. The calibrator output signal is fed to the receiver antenna circuit through a buffer amplifier, Q4, 2SC735Y.

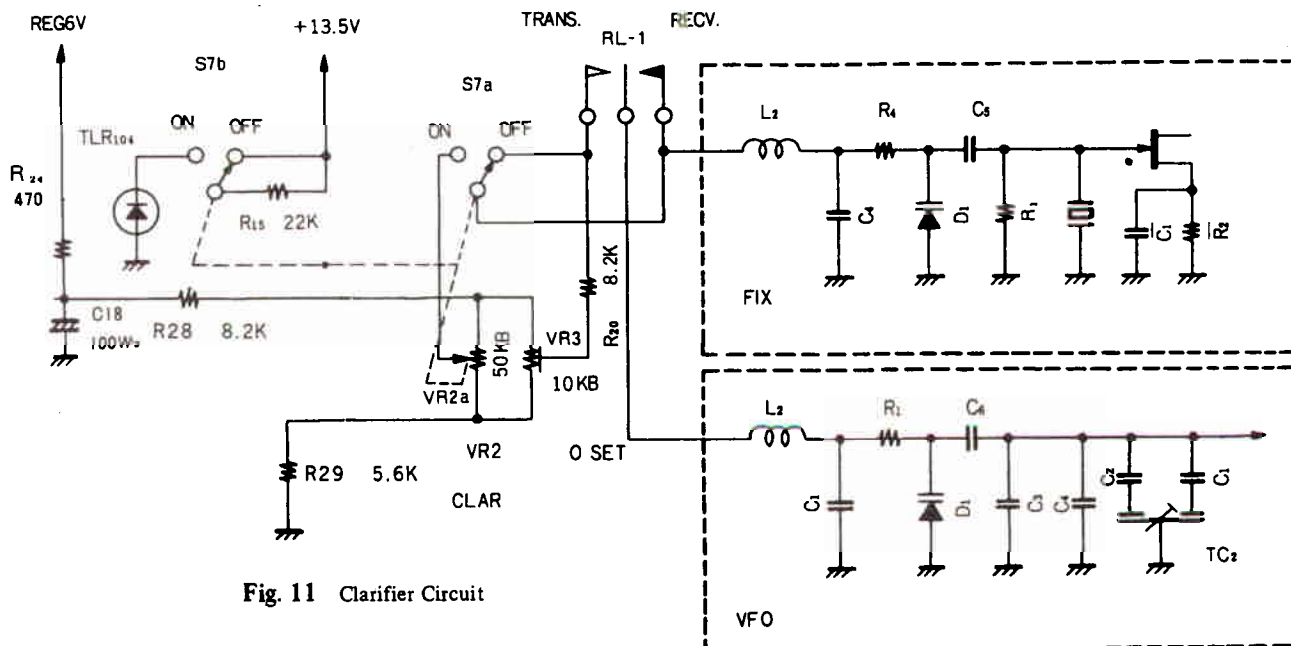

Fig. 11 Clarifier Circuit

CLARIFIER CIRCUIT

A control voltage is applied to a varactor diode, D1, 1S2236, through a relay contact and the clarifier switch, to shift the VFO frequency for receiver offset tuning. This voltage is also used to shift the frequency of the FIX crystals.

When the clarifier switch is ON, the control voltage is applied through R28, VR2a, S7a, and a relay contact to the varactor diode. When the clarifier is OFF or in transeive, the control voltage is applied through R28, VR3, S7a, and a relay contact to the varactor diode.

VHF CONVERTERS

(1) 6 METER CONVERTER

A 6 meter signal from the antenna input jack is fed to a MOS FET RF amplifier, Q1, 3SK35, through passband transformers, T611 and T612. The amplified signal is then fed through interstage transformers, T613 and T614, to a gate of mixer, Q2, 2SK19GR, where the incoming signal is mixed with a heterodyne signal delivered from a crystal oscillator, Q3, 2SC372Y, producing a 28 MHz through 30 MHz IF signal. The crystal oscillator, Q3, generates a 22 MHz or 24 MHz signal to cover the entire 6 meter band. Crystals, X1 and X2, are selected by the diode switch. The IF signal is fed through T615, T616 and the VHF switch to the input circuit of the FR-101.

(2) 2 METER CONVERTER

A 2 meter signal from the antenna input jack is fed to a MOS FET RF amplifier, Q1, 3SK40M, through T211, and T212. The amplified signal is then fed through slit-resonators, T212 through T215, to a gate of mixer, Q2, 2SK19GR, where the incoming signal is mixed with a heterodyne signal through 30 MHz IF signal. The crystal oscillator, Q3, 2SC372Y, generates a 38.666 MHz or 39.333 MHz signal which is multiplied to 116 MHz or 118 MHz by a diode tripler, D2, 1S1555. This

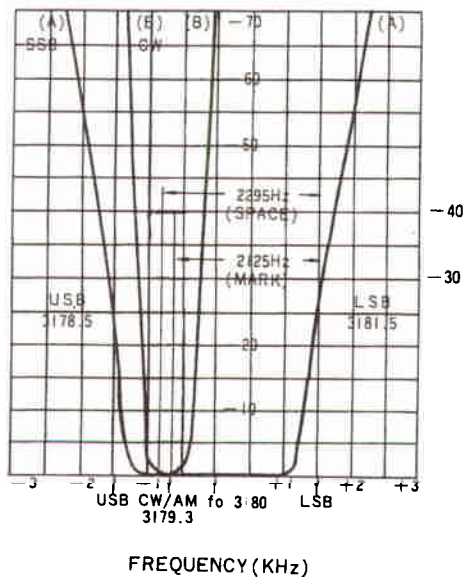

heterodyne signal is fed to a mixer through a buffer amplifier, Q4, 2SC784R. The IF signal from the mixer is fed to the input circuit of the FR-101 through T217 and the VHF switch.

NOTE: The earlier model has one crystal and covers 2 MHz range.

NOTE: RTTY RECEPTION

Since 170 Hz shift is commonly used in recent RTTY operation, the following modification may be recommended so as to use the 600 Hz CW filter in the RTTY reception.

MJ-6 BFO/REG Unit Socket

Remove a white/yellow wire from pin 6 of the MJ-6 and solder this white/yellow wire to pin 4 of the MJ-6.

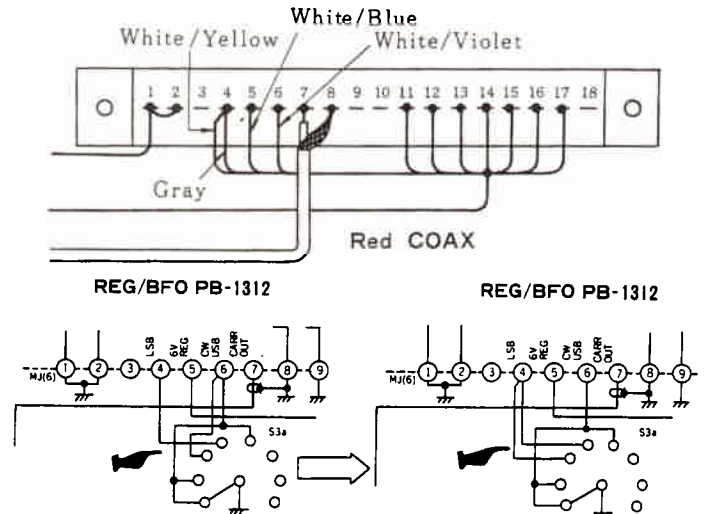

MODE Switch (S₃C wafer)

Disconnect a jumper wire between pin 5 and 6. Connect pin 5 to 7 with a jumper wire. Connect pin 6 to 8 with a jumper wire.

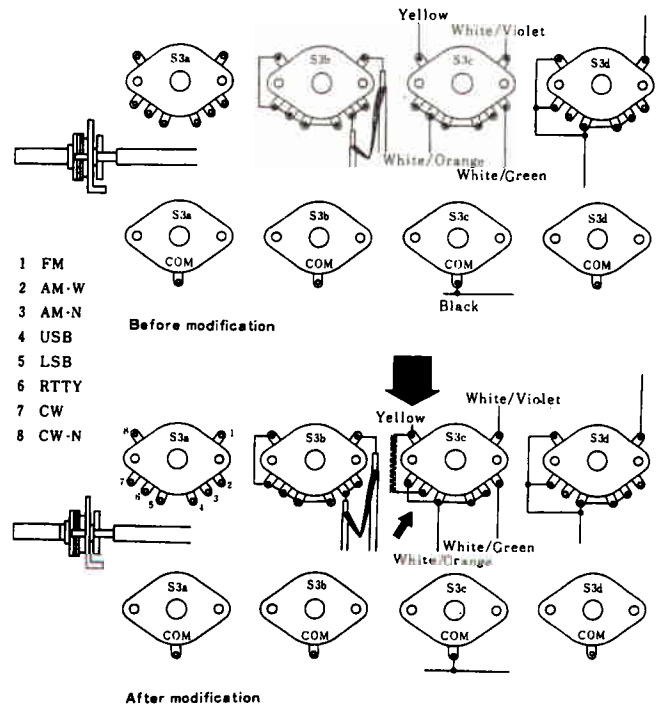

ALIGNMENT

GENERAL

The FR-101 has been carefully aligned and tested at the factory before shipment and, with normal usage, it should not require other than the usual attention given to any electronic equipment. Service or replacement of major component may require substantial realignment, but, under no circumstances, should realignment be attempted unless the operation of the receiver is fully understood and the malfunction has been fully analyzed and traced to misalignment. Service work should only be performed by experienced personnel using proper test equipment.

RF UNIT, PB-1225

(1) Oscillator Transformer, T110

- Connect the RF probe of a VTVM to the junction point between C27 and R11 (first local input).
- Set the BAND switch to the 11 meter band (10A band for FR-101 in which the 11 meter band is not installed).
- Adjust the slug of T110 for maximum VTVM reading.
- Check the VTVM reading when the BAND switch position is changed between 11 through to 10D. If the VTVM reading varies with the different BAND switch position, adjust T110 until the same reading is obtained through the 11 to 10D positions.

(2) Trimmer Capacitors, TC17 thru TC26

These trimmer capacitors are tuning capacitors for T110.

- Set the BAND switch to the 15 meter band.
- Peak TC17 for maximum VTVM reading.
- Slowly turn TC17 in direction of decreasing capacitance and set it to the point where the VTVM reading is 90% of the peak reading. (Refer to Figure 13.)
- Repeat the above procedures for the other bands as shown in Table 10.

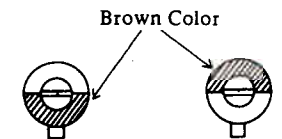

Fig. 13 Minimum Maximum

STEP	BAND	TRIMMER	OUTPUT VOLTAGE (V)	CHECK BAND
1	11	—	2.0	11~10D
2	15	TC17	"	15~13
3	16	TC18	"	—
4	19	TC27	"	—
5	20	TC19	"	—
6	25	TC20	"	—
7	31	TC21	"	—
8	40	TC23	"	—
9	60	TC24	"	—
10	80	TC25	"	—
11	160	TC26	"	—

Table 10

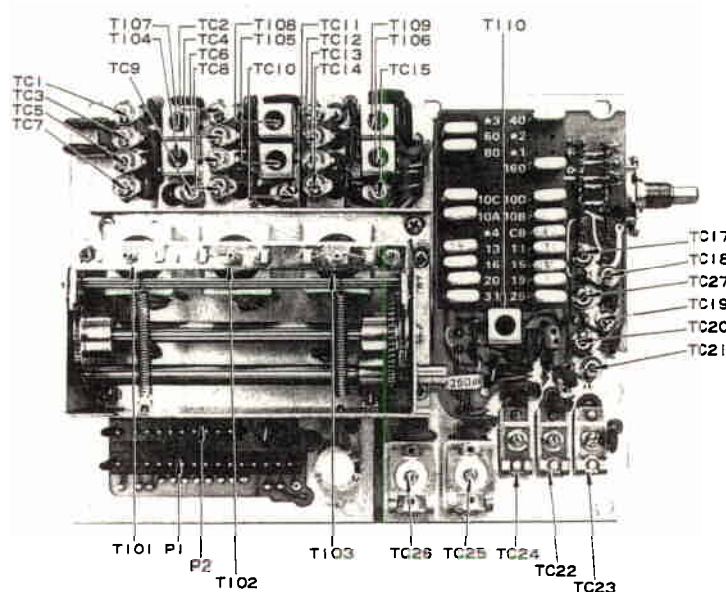

Fig. 12

(3) Preselector and Associated Trimmers

A standard signal generator is required for this alignment. When a signal generator is not available, use the calibrator signal with the antenna terminal terminated with 50 ohm resistor. Connect the signal generator output to the antenna terminal marked HF. It is recommended to adjust the output level of the signal generator for an S-6 reading on the S-meter with the RF GAIN control at a fully clockwise position to avoid saturation during the following alignment.

Set the white pointer of the PRESELECTOR knob to 4.1 on the unity scale. Adjust the slugs of T101, T102 and T103 until the head of the slugs come to same level as the head of the coil bobbins.

Step 1, 2 and 3

Set the BAND switch to 10D, main tuning dial to 0 on the green scale (30 MHz) and the red pointer of PRESELECTOR to 3.3 on the unity scale. Set the signal generator to 30MHz and tune the FR-101 in with the main tuning dial. Adjust TC9, TC10 and TC15 for maximum S-meter reading.

Step 4, 5 and 6

Set the BAND switch to 10A, main tuning dial to 0 on the white scale, the red pointer of PRESELECTOR to 2.8 on the unity scale. Set the signal generator to 28 MHz and tune the FR-101 in. Adjust the slugs of T101, T102 and T103 for maximum S-meter reading.

Step 7

Repeat step 1 through step 6.

Step 8 thru 25

Perform as shown in Table 11 and as described above.

BANDPASS IF UNIT, PB-1396

- a. Set the BAND switch to the 20 meter position and the CALIB switch ON. Tune the FR-101 to a 14,250 KHz calibrator signal.
- b. Peak T111, T112 and T113 for maximum S-meter reading.

STEP	BAND	DIAL	PRE-SELECT	CAPACITOR
1	10D	G 000	R 3.3	TC9
2	"	"	"	TC10
3	"	"	"	TC15
4	10A	W 000	R 2.8	T101
5	"	"	"	T102
6	"	"	"	T103
7	Repeat procedures 1 ~ 6.			
8	160	G 900	R 10	T104
9	"	"	"	T105
10	"	"	"	T106
11	80	G 750	R 9.1	T107
12	"	"	"	T108
13	"	"	"	T109
14	60	"	W 4.5	TC1
15	"	"	"	TC2
16	"	"	"	TC11
17	40	W 250	R 1.3	TC3
18	"	"	"	TC4
19	"	"	"	TC12
20	19	"	W 9	TC5
21	"	"	"	TC6
22	"	"	"	TC13
23	11	G 750	W 7.7	TC7
24	"	"	"	TC8
25	"	"	"	TC14

Table 11

NOISE BLANKER & MIXER UNIT, PB-1551

(1) T114 and T115

Set the RF-101 as described in the above procedure of PB-1396, and peak T114, and T115 for maximum S-meter reading.

(2)

VR2 and VR3 are set to a maximum resistance position and are not necessary to adjust.

(3) VR1

This potentiometer may be adjusted when the FR-101 is

used in transceive operation in conjunction with our FT-101E/277E transceiver.

- a. Set the SELECT switch of FT-101E/277E to INT position and the SELECT switch of FR-101 to EXT position.
- b. Set the MODE switch of FT-101E/277E to TUNE position and the BAND switch to 40 and tune the transmitter at 7,100 KHz for maximum output into a dummy load.
- c. Set the BAND switch of the FR-101 to the 80 meter position and the MODE switch to SSB (LSB or USB) position. Advance the MONITOR control until a beat can be heard while the FT-101E/277E is transmitting as described in Step (b).
- d. Adjust VR1 for minimum beat note.

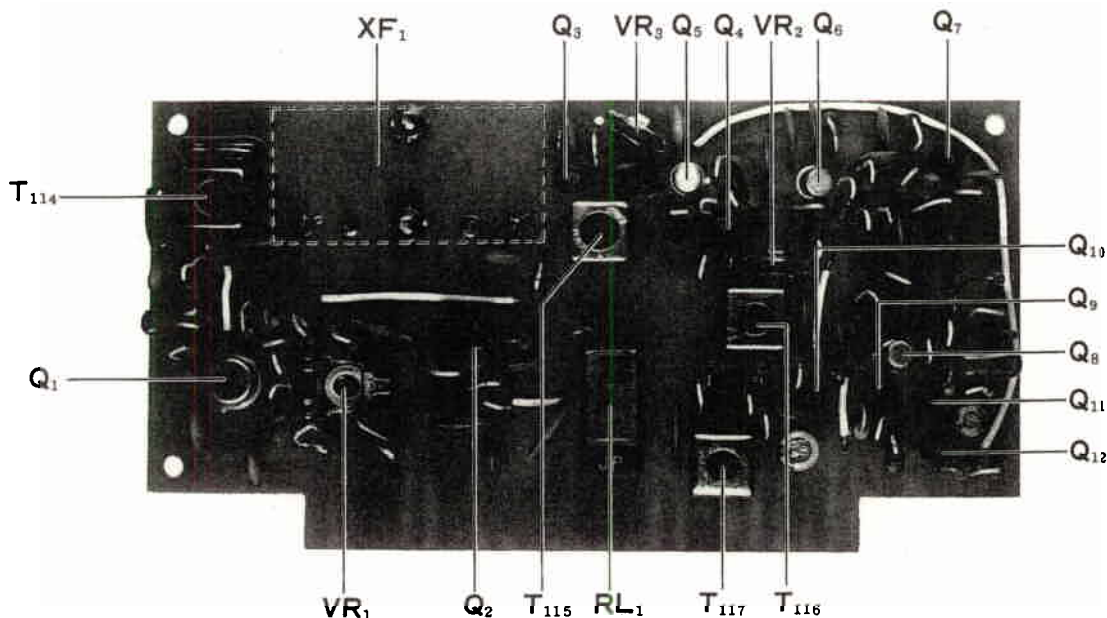

Fig. 14 NB-MIX UNIT

IF UNIT, PB-1251

(1) T119 and T120

Peak T119 and T120 for maximum S-meter reading as described in the T114 adjustment.

(2) VR1

Disconnect the antenna from the antenna jack. Set the MODE switch to USB position and adjust VR1 for minimum S-meter reading. Then set the MODE switch to

LSB position and adjust VR1 for minimum S-meter reading. Repeat these procedures for minimum S-meter reading at both USB and LSB positions.

(3) VR2

Connect the signal generator to the antenna jack of FR-101 and set the frequency to 14,250 KHz with an output level of 0.1 volt. Tune the FR-101 to the signal generator. Peak the PRESELECTOR and set the RF GAIN control fully clockwise. Adjust VR2 for S-9 +60 dB S-meter reading.

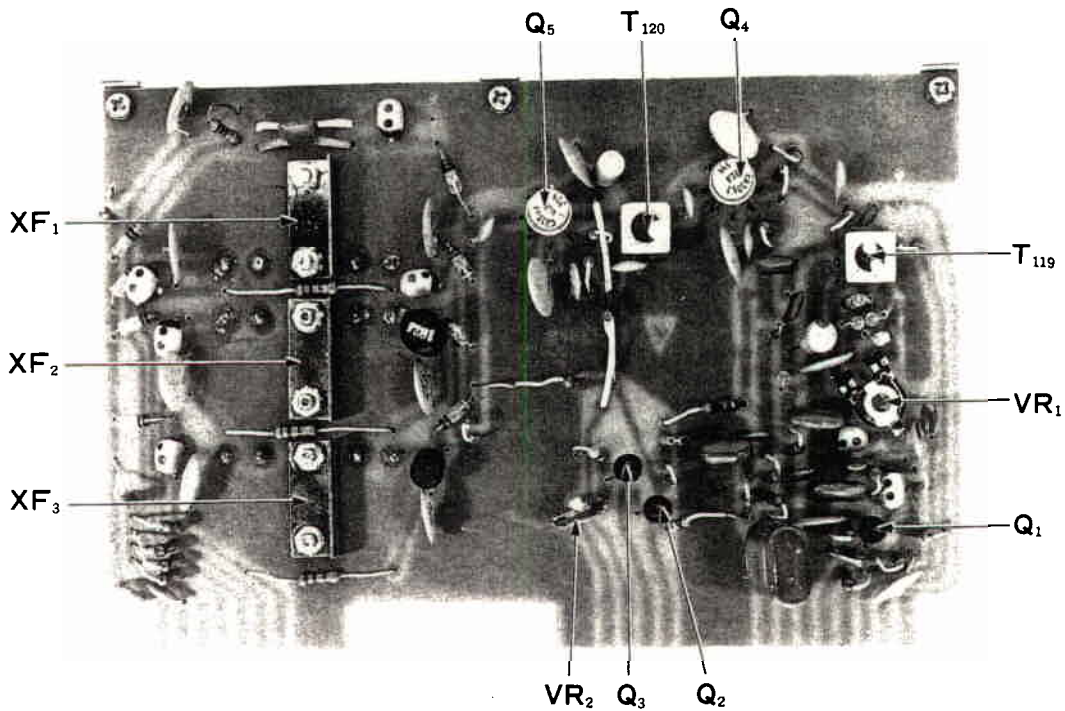

Fig. 15 IF UNIT

AF UNIT, PB-1268

(1) VR1

Adjust VR1 until the 25 KHz multivibrator locks in and the 25 KHz calibrator signal can be heard at every 25 KHz.

(2) VR2

Adjust VR2 for comfortable listening level of the sidetone signal when the FR-101 is used with FT-101E/277E in transceive operation.

(3) TC1

Receive WWV or JJY signal on AM Narrow mode and adjust TC1 for zero beat against 100 KHz calibrator signal.

REGULATOR & BEAT FREQUENCY OSCILLATOR UNIT, PB-1549

(1) TC1

Connect a frequency counter to Pin 7 of MJ-6 and adjust TC1 until the frequency of the RTTY oscillator becomes exactly 3,177.45 KHz.

(2) TC2

Adjust TC2 exactly to 3,181.5 KHz as described in (1).

(3) TC3

Adjust TC3 exactly to 3,178.5 KHz as described in (1).

(4) VR1

Connect the VTVM between Pin 14 of MJ-6 and ground and adjust VR1 for 6 volt VTVM reading

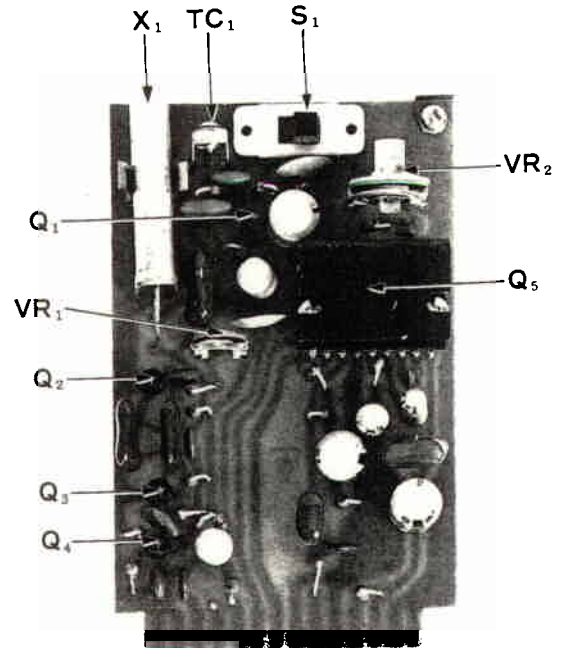

Fig. 16 AF-CALIB UNIT

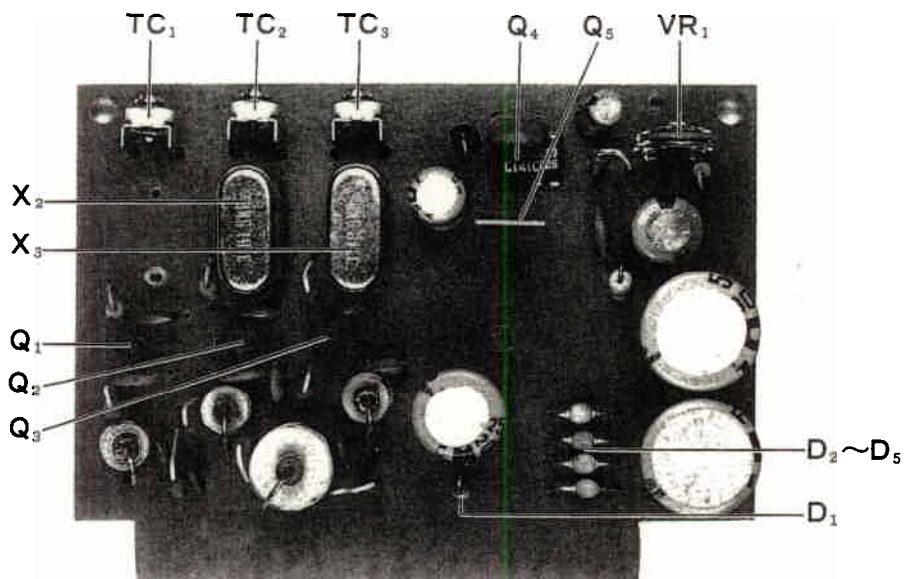

Fig. 17 REG-BFO UNIT

VFO UNIT, PB-1307

(1) TC1

Connect the frequency counter to the output terminal of the VFO unit. Set the main tuning dial to 14,000 KHz, i.e. the white scale to zero and subdial to zero. Adjust TC1 for 9,200 KHz.

(2) TC2

This trimmer capacitor is used to adjust the temperature compensation. At the setting illustrated in Figure 18, the oscillator frequency decreases with a temperature rise, and at the setting of Figure 19, the oscillator frequency rises with a temperature rise.

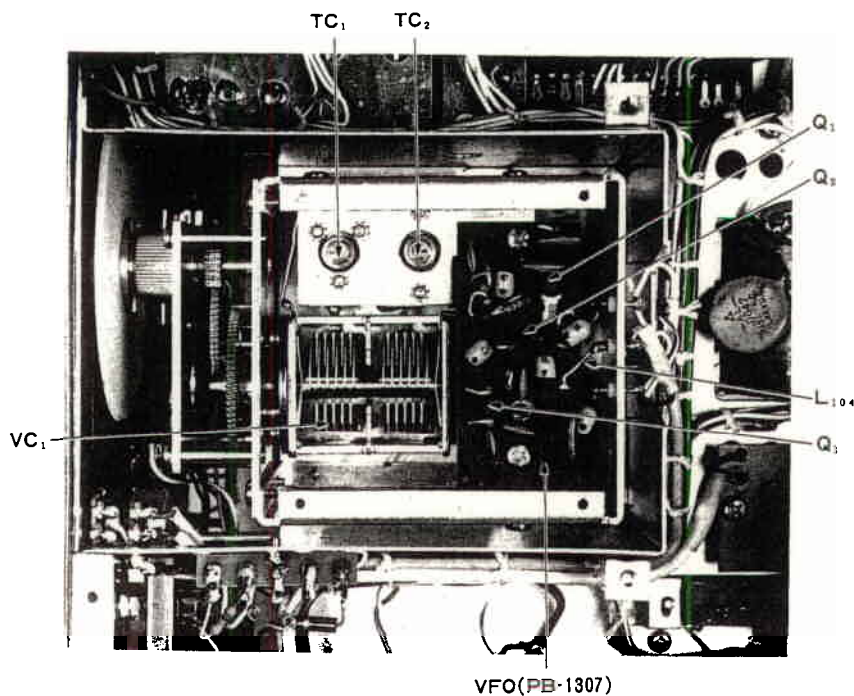

Fig. 20

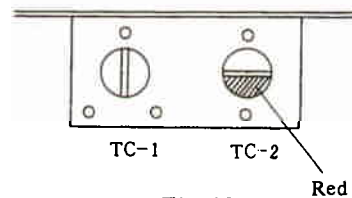

Fig. 18

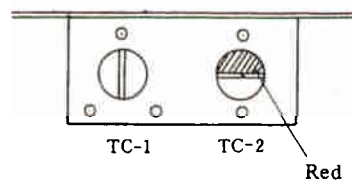

Fig. 19

VFO BUFFER UNIT, PB-1310

(1) L102

Another receiver is required for this alignment to monitor the spurious signal.

- Connect the FR-101 and FT-101E/277E as illustrated in Figure 7.
- Connect a dummy load to the antenna jack of the FT-101E/277E.
- Set the SELECT switches of the FR-101 and FT-101E/277E to the EXT position.
- Set the BAND switches of the FR-101 and FT-101E/277E to the 15 meter band.
- Tune the FR-101 to 21.2 MHz.
- Tune the FT-101E/277E to maximum power output with the MODE switch at the TUNE position.
- Tune the test receiver to the spurious signal which can be heard around 21.22 MHz and adjust L102 for a minimum S-meter reading at the test receiver.

FIX UNIT, PB-1311

(1) L101

- Connect the RF probe of a VTVM to the output terminal.
- Insert a crystal(s) in a crystal socket(s) and set the SELECT switch to the channel where the crystal is installed.
- Peak L101 for a maximum VTVM reading and then rotate the slug of L101 $\frac{1}{4}$ turn counter-clockwise..

(2) TC1 thru TC4

Adjust TC1 through TC4 to compensate for the crystal tolerance.

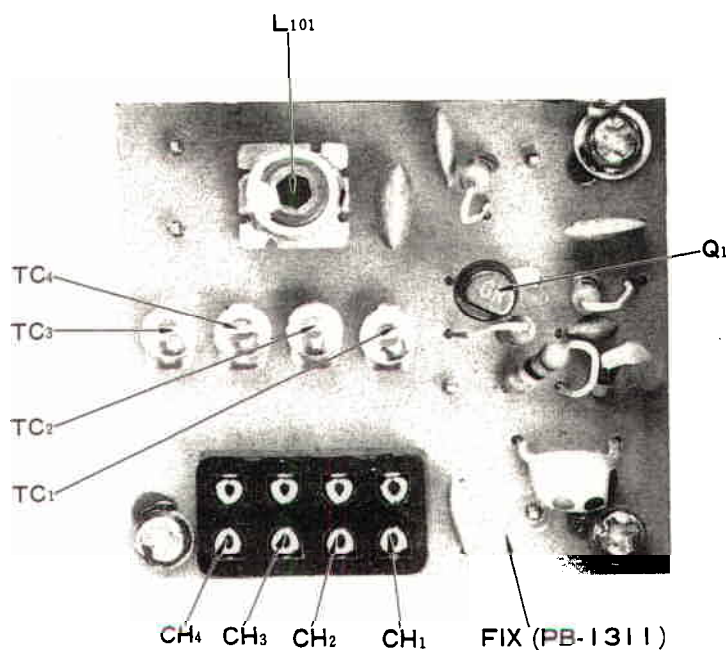

Fig. 21

IF TRAP COIL, (A) PB-1548 & (B) PB-1309

(1) T123

- Set the BAND switch to the 40 meter band and the red pointer of the PRESELECTOR to 10 on the unity scale.
- Connect the signal generator and set its frequency to 5,900 KHz with an output level of 60 dB.
- Locate this signal with main tuning knob and adjust T123 for minimum S-meter reading.

(2) T124

This trap coil functions when the FR-101 is in transceive operation. Adjust T124 for a minimum beat tone as described in the VR1 adjustment of the Noise Blanker and Mixer Unit alignment. Adjust the VR1 and T124 alternately for a minimum beat note.

FM UNIT, PB-1269

(1) T301 and T302

- Connect the DC probe of a VTVM to the test point shown as TP in Figure 22.
- Set the BAND switch to 20 meter, the MODE switch to AM, and the CALIB switch to ON.
- Tune the FR-101 to the calibrator signal and then turn the MODE switch to the FM position.
- Peak T302 for maximum VTVM reading. When the VTVM reading shows a minus direction, reverse the polarity of the VTVM.
- Adjust T301 for a zero VTVM reading.

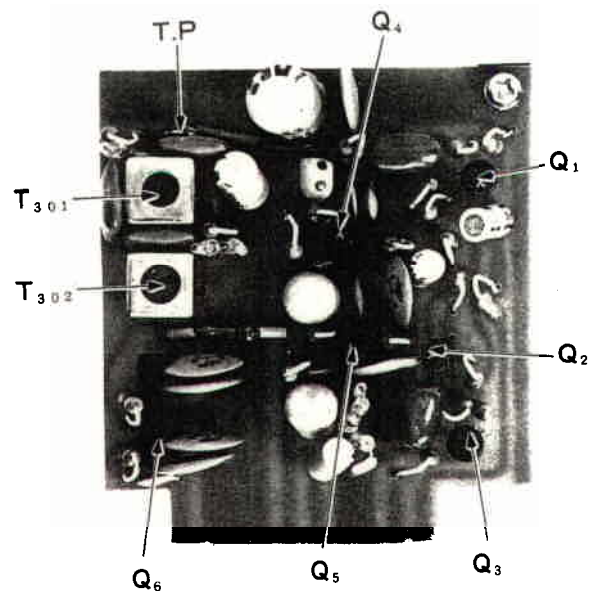

Fig. 22 FM UNIT

6 METER CONVERTER UNIT, PB-1305A

(1) T611, T612, T613 and T614

It is not recommended to align these coils, as special measuring instruments are required for this alignment.

(2) T617 and T618

- Connect the RF probe of a VTVM to the output terminal of T618.
- Peak T617 for a maximum VTVM reading. Then turn the slug $\frac{1}{4}$ turn counter-clockwise.
- Peak T618 for a maximum VTVM reading. When the oscillation stops with the T618 alignment, realign T617 for stable oscillation.

(3) T615 and T616

Receive a 51 MHz signal and peak T615 and T616 for a maximum S-meter reading.

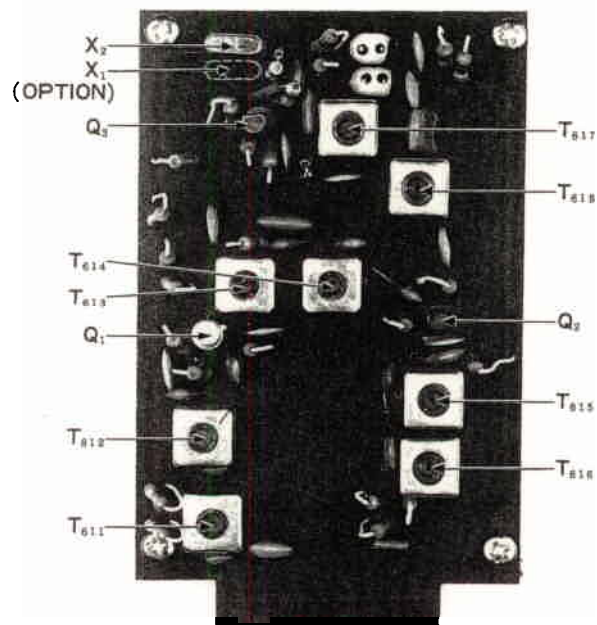

Fig. 23 6m CONVERTER PB-1305A

2 METER CONVERTER UNIT, PB-1306A

(1) T211, T212, T213, T214 and T215

It is not recommended to align these coils, as special measuring instruments are required for this alignment.

(2) T218, T219, and T220

- Connect the RF probe of a VTVM to the output terminal of T220.
- Peak T218 for a maximum VTVM reading. Then turn the slug $\frac{1}{4}$ turn counter-clockwise.

- Peak T219 and T220 for a maximum VTVM reading. When the oscillation stops with the alignment of T219, realign T218 for a stable oscillation.

(3) T216 and T217

Receive a 145 MHz signal and peak T217 for a maximum S-meter reading.

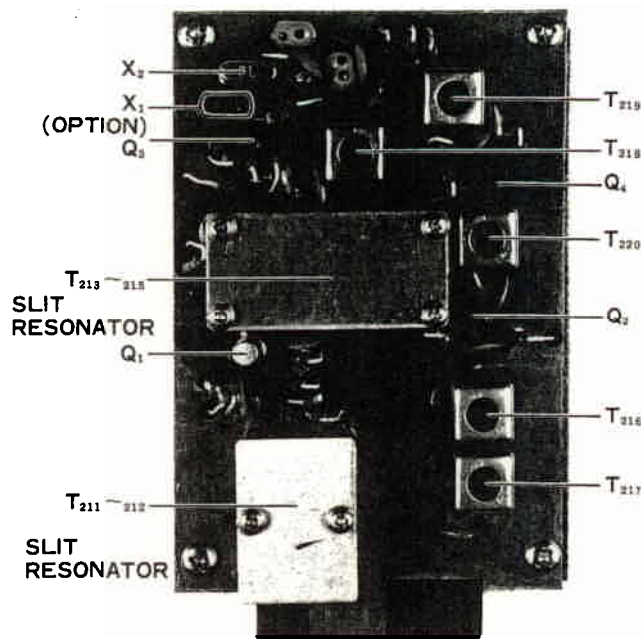

Fig. 24 2m CONVERTER PB-1306A

MAIN CHASSIS

(1) VR3

- Set the BAND switch to 20, the MODE switch to USB, the CALIB switch to ON and the CLARIFIER to zero. Zero beat the FR-101 against the calibrator signal with the main tuning dial.
- Set the CLARIFIER to the OFF position and adjust VR3 for a zero beat.

(2) VR5

Adjust VR5 for optimum performance of noise blanker. Too high of a setting of this control may cause cross modulation.

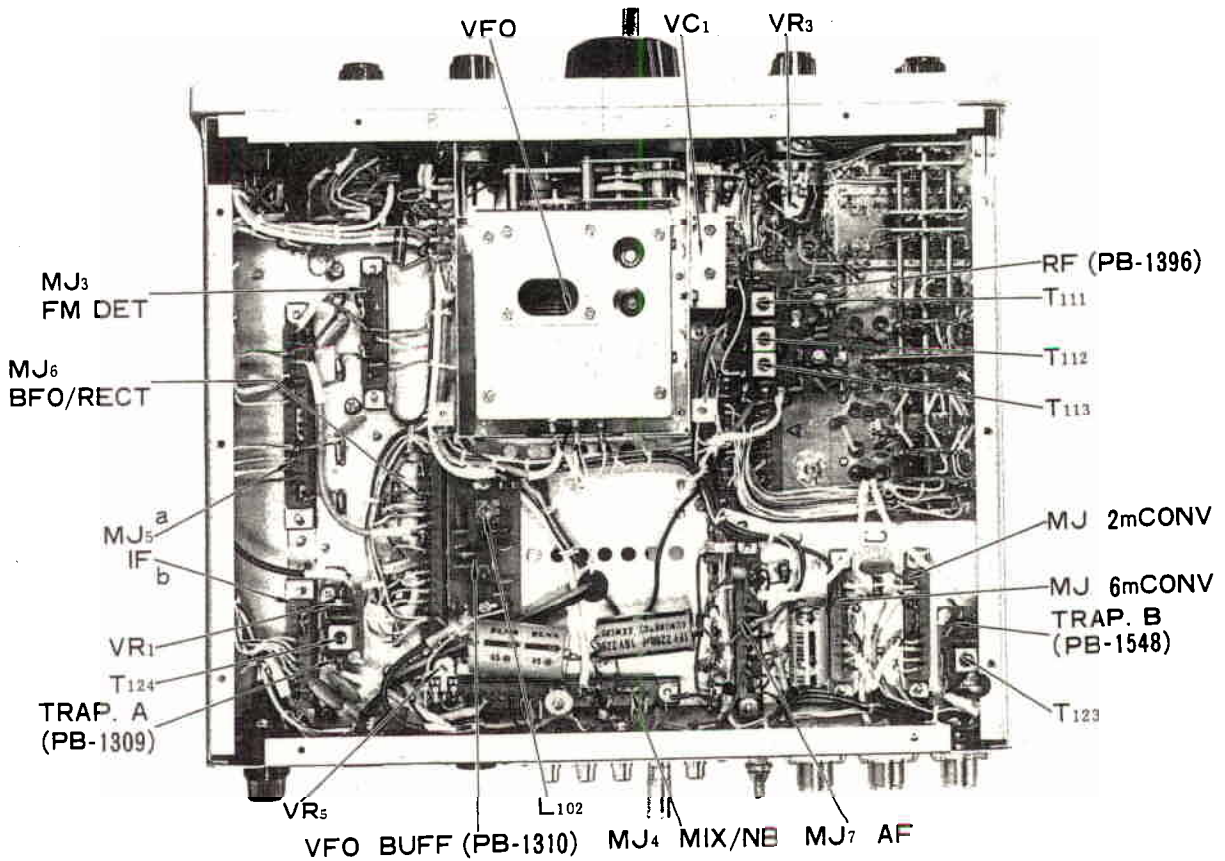
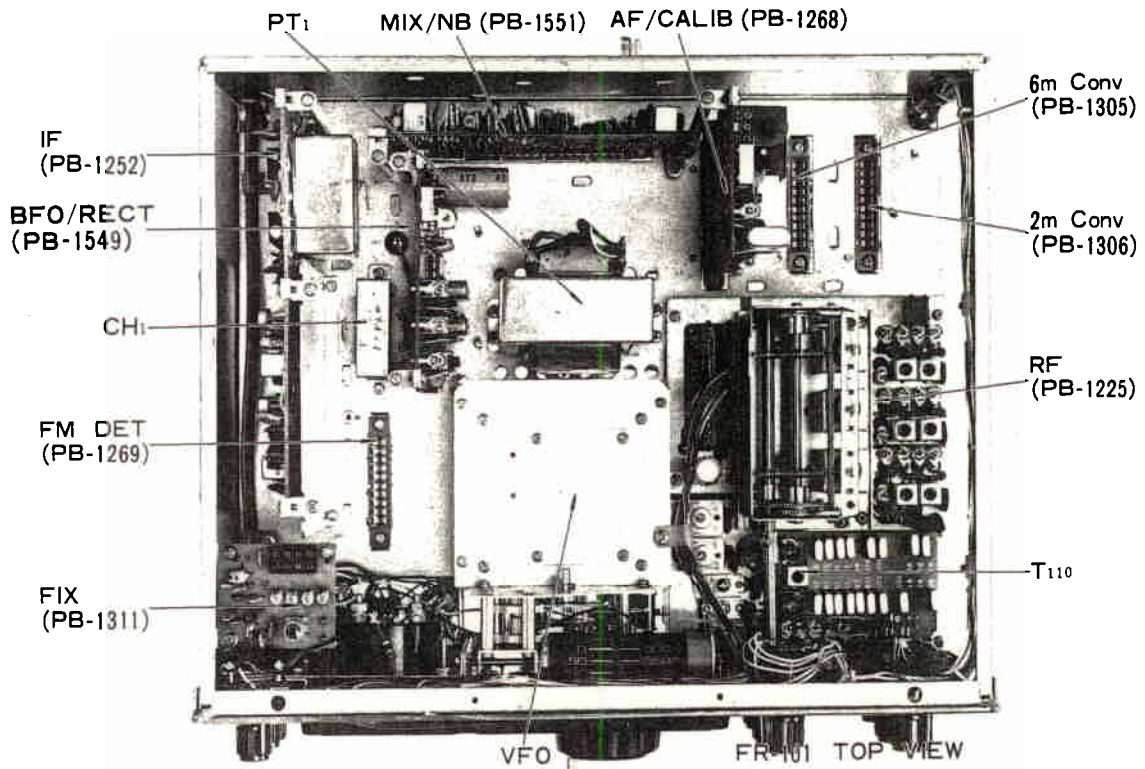

RESISTANCE & VOLTAGE MEASUREMENTS

MJ PIN	RESISTANCE (Ω)								VOLTAGE (V)							
	1	2	3	4	5a	5b	6	7	1	2	3	4	5a	5b	6	7
1	800	800	∞	∞	∞	E	E	E	9	9	0	0	0	E	E	E
2	0	0	E	E	E	E	E	E	0	0	E	E	E	E	E	E
3	E	E	E	E	20	E	2.6	0	E	E	E	E	13.5	E	0.5	0
4	E	E	E	E	4K	1.8K	2.7K	NC	E	E	E	E	2	13.5	0.5	NC
5	E	E	∞	∞	50K	1.8K	24	1.6K	E	E	0	0	0	13.5	6	13.5
6	E	E	900	E	E	0	0	5K	E	E	0	E	E	0	0	0
7	E	E	E	E	1.7M	1.8K	4K	20	E	E	E	E	0	13.5	2	14.5
8	0	0	E	∞	∞	20	E	E	0	0	E	0	0	13.5	E	E
9	0	0	900	0	E	E	E	0	0	0	1	0	E	E	E	0
10	20	20	∞	E	E	0	NC	E	13.5	13.5	0	E	E	0	NC	E
11				20	E		4	1K				13.5	E		AC 15	0
12				600	E		12	0				13.5	E		AC 11	0
13				4K	20		NC	E				3.2	13.5		NC	E
14				4K	800		24	E				3.2	9		6	E
15				4K	800		12					3.2	9		AC 12	
16				0	95		12					0	0		AC 12	
17				0	E		20					0	E		14.5	
18				0	E		E					0	E		E	
19				E								E				
20				20								13.5				
21				100K								13.5				
22				100K								13.5				

The value may vary with the polarity of test lead.
Above chart shows the higher values.

MODE : USB
Measured with VTVM.

Table 12

PARTS LIST

MAIN CHASSIS				PT	POWER TRANSFORMER	
Q TRANSISTOR				1	SA2-10594	
1	2SC735Y					
				M	METER	
D DIODE				1	S.METER	
1	Ge	1S1007				
5	Zener 1S993					
4	Zener WZ061			S	SWITCH	
2	Zener WZ110			1	PUSH SWITCH	
				5,6	1-4-3	
				3	4-4-8	
R RESISTOR				4	3-6-6	
5,6	1/4 W	56Ω		2	2-4-5	
1	1/4 W	75Ω				
2,3	1/4 W	100Ω				
4,9	1/4 W	220Ω		J	JACK	
19	1/4 W	470Ω		1,2,3	JSO-239	
31	1/4 W	560Ω		4	SG-7814	
10,14,18	1/4 W	1KΩ		5	SG-7615	
15	1/4 W	2.2KΩ		6~9,11	SN-7017 RCA JACK	
8,30	1/4 W	3.3KΩ		10	SI-6403-1	
29	1/4 W	5.6KΩ		12	QMS-AB4M	
20,28	1/4 W	8.2KΩ				
21	1/4 W	22KΩ				
12,26	1/2 W	10Ω		MJ	MULTI JACK	
23	1/2 W	56Ω		1~3,5b	10P	
11,25	1/2 W	100Ω		7	14P	
22	1/2 W	220Ω		5 a,6	18P	
27	1/2 W	330Ω		4	22P	
17	1/2 W	47KΩ				
32	1 W		22Ω			
16	1 W		100Ω	PL	PILOT LAMP	
				1	BF026-29730A	14V 0.2A
				2~18	BQ041-32503A	14V 0.65A
VR POTENTIOMETER				19,20	LED TLR-104	
1 a,b	EVK-A2AR	10339	5KA/5KB			
2	EVF-B8QF	15355	10KB/50KB			
3	TR-11R 10KB					
4	EVH-BOS	15B53	5KB	RF UNIT		
6 a,b	EVK-A2AR	10604	50KA/5KB	PB	PRINTED CIRCUIT BOARD	
				1225(A~Z) RF BOARD		
C CAPACITOR				Q TRANSISTOR		
DIPPED MICA				1	2SC372Y	
14	500WV		180PF			
CERAMIC DISC				D	DIODE	
				Varactor 1S2689		
2,3,12,15	50WV		0.01μF			
1,4,11	50WV		0.047μF			
6,7	1.4KV		0.0047μF	X	CRYSTAL	
MYLAR				1	160m	HC-25/U 7.52MHz
5	50WV		0.01μF	2	80m	HC-25/U 9.52MHz
ELECTROLYTIC				4	60m	HC-25/U ★10.52MHz
17	16WV		47μF	7	40m	HC-25/U 13.02MHz
8	16WV		1000μF	8	31m	HC-25/U ★15.52MHz
9	16WV		2000μF	9	25m	HC-25/U ★17.52MHz
				10	20m	HC-25/U 20.02MHz
				11	19m	HC-25/U ★21.02MHz
VC VARIABLE CAPACITOR				12	16m	HC-25/U ★23.52MHz
1	C-332A			13	15m	HC-25/U 27.02MHz
				14	13m	HC-25/U ★27.52MHz
				15	11m	HC-25/U ★31.52MHz
L INDUCTOR				17	CB	HC-25/U ★33.02MHz
1,2,3	RFC		250μH	18	10mA	HC-25/U 34.02MHz
				19	10mB	HC-25/U 34.52MHz
				20	10mC	HC-25/U ★35.02MHz
CH CHOKE COIL				21	10mD	HC-25/U ★35.52MHz
1	20mH		0.5A			

R	RESISTOR		Q	FET	
4	1/4W	56Ω	1,2	3SK35	
3,7	1/4W	100Ω			
5	1/4W	180Ω			
2	1/4W	10KΩ	R	RESISTOR	
1	1/4W	15KΩ	13	1/4W	56Ω
8	1/4W	22KΩ	12	1/4W	100Ω
6	1/4W	100KΩ	6	1/4W	150Ω
			9	1/4W	220Ω
			7	1/4W	1.8KΩ
C	CAPACITOR		4	1/4W	22KΩ
	DIPPED MICA		11	1/4W	33KΩ
16	500WV	1PF	1,2,3,5,8	1/4W	100KΩ
18	500WV	2PF	10	1/4W	220KΩ
13	500WV	3PF			
43,44	500WV	10PF	C	CAPACITOR	
6,10	500WV	15PF		DIPPED MICA	
2,27	500WV	20PF	6	500WV	0.5PF
33,42	500WV	30PF	4	500WV	5PF
34,45	500WV	50PF	7,8,9	500WV	60PF
15,17,24,28	500WV	60PF	1	500WV	100PF
35	500WV	80PF		CERAMIC DISC	
36	500WV	100PF	2,3,5,10,11,13	50WV	0.01μF
29	500WV	150PF	12	50WV	0.047μF
38	500WV	200PF			
12,14,23	500WV	220PF	VC	VARIABLE CAPACITOR	
37	500WV	250PF	1	C-332-A	
9,11,22	500WV	280PF			
39	500WV	400PF	T	TRANSFORMER	
4,7	500WV	470PF	111	BPF COIL	R12-4431
20	500WV	500PF	112	BPF COIL	R12-4431
1,3,19	500WV	1200PF	113	BPF COIL	R12-4431
	CERAMIC DISC				
25,26,30,40,46	50WV	0.01μF			
31	50WV	0.047μF			
	ELECTROLYTIC				
41	16WV	470μF			
TC	TRIMMER CAPACITOR			MIX & N.B UNIT	
	CERAMIC		PB	PRINTED CIRCUIT BOARD	
1~6,11~13,17~21,27	ECV-1ZW 50×32	50PF	1551(A~Z)	MIX & NB BOARD	
7~10,14,15	ECV-1ZW 20×32	20PF			
	MICA		Q	IC, FET & TRANSISTOR	
22~24	B2PY	100PF	1	IC	MC-1496G
25,26	A4P3	300PF	5,6,8	FET	3SK40M
L	INDUCTOR		3,4		2SK19GR
1	RF CHOKE	10μH	2,9~12	Tr	2SC372Y
2	RF CHOKE	250μH	7		2SC784R
T	TRANSFORMER		D	DIODE	
101	ANT COIL A	#0451	1~6	Ge	1S188FM
102	RF COIL A	#0470	XF	CRYSTAL FILTER	
103	MIX COIL A	#0460	1	XF-30D	(FM)★
104	ANT COIL B	R12-4432			
105	RF COIL B	R12-4432	R	RESISTOR	
106	MIX COIL B	R12-4432	22,23	1/4W	4.7Ω
107	ANT COIL C	R12-4433	15,19,29,34,40,41	1/4W	100Ω
108	RF COIL C	R12-4433	13	1/4W	150Ω
109	MIX COIL C	R12-4433	35	1/4W	220Ω
110	OSC COIL	R12-4435	30,32	1/4W	330Ω
			2,14,38	1/4W	470Ω
			17,21,49	1/4W	560Ω
J	JACK		1	1/4W	820Ω
1	PIN CONNECTOR	15P	5~7,10,25	1/4W	1KΩ
2	PIN CONNECTOR	10P	4	1/4W	1.2KΩ
3,4	CRYSTAL SOCKET	12P	18	1/4W	1.5KΩ
			39	1/4W	2.2KΩ
			11,28,33	1/4W	3.3KΩ
S	SWITCH		3,8,9,24,36,46,53	1/4W	10KΩ
8	S-21-P	12-12-12	12,37,42,43	1/4W	22KΩ
			48	1/4W	33KΩ
			47	1/4W	56KΩ
	RF AMP UNIT		20,26,31,44,50~52,54	1/4W	100KΩ
PB	PRINTED CIRCUIT BOARD		45	1/4W	220KΩ
1396(A~Z)	RF AMP BOARD				

VR	POTENTIOMETER			14, 20	1/4 W	1K Ω	
1	EVL-S3AA	00B54	50K Ω B	34	1/4 W	1.5K Ω	
2	EVL-S0AA	00B23	2K Ω B	15, 21	1/4 W	2.2K Ω	
3	EVL-S0AA	00B52	500 Ω B	2, 38	1/4 W	4.7K Ω	
				22, 23, 27, 29	1/4 W	6.8K Ω	
C	CAPACITOR			4, 5, 19, 24-26, 28	1/4 W	10K Ω	
	DIPPED MICA			1, 9	1/4 W	22K Ω	
6		50WV	27PF	11	1/4 W	56K Ω	
8, 19		50WV	39PF	10, 13, 36	1/4 W	100K Ω	
22, 26, 33-35, 39, 40		50WV	100PF	30-32	1/2 W	100 Ω	
9, 14		50WV	220PF				
15		50WV	1000PF				
	CERAMIC DISC			VR	POTENTIOMETER		
1		50WV	0.001 μ F	1	EVL-S3AA	00B52	500 Ω B
4, 5, 7, 10, 12, 16, 17		50WV	0.01 μ F	2	TR-11R		1K Ω B
20, 23-25, 27-32, 41							
11, 21		50WV	0.047 μ F	C	CAPACITOR		
	MYLAR				DIPPED MICA		
42		50WV	0.0047 μ F	13		500WV	10PF
2, 3, 13, 36		50WV	0.1 μ F	12		500WV	30PF
	ELECTROLYTIC			14, 34		500WV	100PF
37		16WV	10 μ F	3, 5		500WV	300PF
38		16WV	22 μ F		CERAMIC DISC		
L	INDUCTOR			16, 20, 28		50WV	0.001 μ F
3		RFC	6.8 μ H	8, 10, 17, 23, 25, 40-45		50WV	0.01 μ F
4		RFC	68 μ H	2, 6, 9, 18, 19, 26, 27		50WV	0.047 μ F
1, 2		RFC	1mH	29-31, 35-38, 46			
T	TRANSFORMER				MYLAR		
114		R12-4129		4		50WV	0.001 μ F
115		R12-4424		7		50WV	0.022 μ F
116, 117		# 220067		1		50WV	0.047 μ F
				15		50WV	0.1 μ F
				21		50WV	0.47 μ F
					ELECTROLYTIC		
RL	RELAY			24		16WV	10 μ F
1		AE5343			INDUCTOR		
				1		RFC	10 μ H
				5-8, 10, 12		RFC	250 μ H
				2, 3, 4		RFC	1mH
				13		RFC TV-245	250 μ H
					TRANSFORMER		
				119, 120		IF COIL	R12-4424
				121, 122		IF COIL	R12-4430
	IF UNIT						
PB	PRINTED CIRCUIT BOARD				BFO & REG UNIT		
1251(A-Z)			IF BOARD	PB	PRINTED CIRCUIT BOARD		
				1549(A-Z)	BFO, REG BOARD		
Q	TRANSISTOR & IC			Q	IC & TRANSISTOR		
1-3			2SC372Y	4		IC	μ PC141C
4, 5			CA3053(TA7045M)	5		Tr	2SA634
				1-3		Tr	2SC372Y
D	DIODE			D	DIODE		
1-5, 7-15		Ge	1S1007	1-5		Si	VO6B
6		Si	1S1555				
XF	CRYSTAL FILTER			X	CRYSTAL		
1		SSB	XF-32A	2		HC-6/U	3181.5kHz
2		AM	XF-30B	3		HC-6/U	3178.5kHz
3		CW	XF-30C				
R	RESISTOR			R	RESISTOR		
7, 8, 18		1/4 W	100 Ω	3, 7, 11		1/4 W	1K Ω
12		1/4 W	150 Ω	15		1/4 W	1.2K Ω
3		1/4 W	180 Ω	14		1/4 W	3.3K Ω
6		1/4 W	470 Ω	1, 5, 9		1/4 W	4.7K Ω
37		1/4 W	560 Ω	2, 6, 10		1/4 W	22K Ω

13	$\frac{1}{2}$ W	1.5 Ω		DIPPED MICA	
16	$\frac{1}{2}$ W	10 Ω	5, 7, 9	50WV	30PF
4, 8, 12	$\frac{1}{2}$ W	4.7K Ω	10	50WV	40PF
			8	50WV	50PF
			1	50WV	100PF
VR	POTENTIOMETER		2	50WV	250PF
1	EVL-SOA, B13	1K Ω B	4, 6	50WV	1000PF
			3	50WV	2200PF
C	CAPACITOR		11, 12	CERAMIC	
				MYLAR	
3, 6, 9	50WV	30PF	14	50WV	0.001 μ F
2, 5, 8	50WV	40PF	21	50WV	0.0047 μ F
	CERAMIC DISC		16	50WV	0.01 μ F
12	50WV	56PF (SL)	19, 23	50WV	0.1 μ F
1, 4, 7, 10, 13	50WV	0.01 μ F	22	50WV	0.2 μ F
	ELECTROLYTIC			ELECTROLYTIC	
17	16WV	10 μ F	17	16WV	10 μ F
11	16WV	47 μ F	18	16WV	22 μ F
14	16WV	100 μ F	13, 15	16WV	100 μ F
18	25WV	220 μ F	20	16WV	220 μ F
15, 16	25WV	1000 μ F			
TC	TRIMMER CAPACITOR		TC	TRIMMER CAPACITOR	
			1	ECV-1ZW 50x40	50PF
1~3	ECV-1ZW	20x40	20PF		
				L	INDUCTOR
L	INDUCTOR		1, 2	RFC	4mH
1~3	RFC	22 μ H			
4	RFC TV-245	250 μ H	S	SWITCH	
			1	SA-119	
				VFO UNIT	
	AF UNIT			CHASSIS	
PB	PRINTED CIRCUIT BOARD		C	CAPACITOR	
1268(A~Z)	AF BOARD			DIPPED MICA	
			10	50WV	6PF
			7	50WV	180PF
Q	TRANSISTOR & IC			CERAMIC	
1~4	2SC735Y		1	50WV	20PF
5	AN214			CERAMIC T.C	
			5	UJ 50WV	2PF
			3	UJ 50WV	7PF
D	DIODE		2	UJ 50WV	20PF
1	Zener	WZ090	6	NPO 50WV	8PF
			4	NPO 50WV	82PF
				CERAMIC FEED THRU	
X	CRYSTAL		8, 9	ECK-L2H	
1	HC-13/U	100kHz			102PE
R	RESISTOR		R	RESISTOR	
3, 10	$\frac{1}{4}$ W	100 Ω	1	$\frac{1}{4}$ W	22 Ω
17	$\frac{1}{4}$ W	120 Ω			
12	$\frac{1}{4}$ W	220 Ω	VC	VARIABLE CAPACITOR	
19	$\frac{1}{4}$ W	1K Ω	1	B5240 DS114	
4, 7	$\frac{1}{4}$ W	4.7K Ω			
1, 9, 18	$\frac{1}{4}$ W	10K Ω			
14	$\frac{1}{4}$ W	15K Ω	TC	TRIMMER CAPACITOR	
15	$\frac{1}{4}$ W	18K Ω	1	AIR TSN-150C	30PF
5	$\frac{1}{4}$ W	27K Ω	2	AIR TSN-170C	10PFx2
6, 13	$\frac{1}{4}$ W	33K Ω			
16	$\frac{1}{4}$ W	56K Ω			
2, 8	$\frac{1}{4}$ W	100K Ω	L	INDUCTOR	
			104	OSC COIL	
			1, 2	RFC	
					250 μ H
VR	POTENTIOMETER				
2	TR-11R	10K Ω B			
1	V160 KRZ-1	5K Ω B			
				OSC BOARD	
			PB	PRINTED CIRCUIT BOARD	
				1412(A~Z) VFO BOARD	
C	CAPACITOR				

Q	TRANSISTOR & FET		3	500WV	60PF
1,2	2SK19GR		CERAMIC DISC		
3	2SC372Y		1,2,4	50WV	0.01 μ F
R	RESISTOR		TC	TRIMMER CAPACITOR	
3,5	$\frac{1}{4}$ W	100 Ω	1~4	ECV-1ZW 20 \times 51	20PF
2	$\frac{1}{4}$ W	150 Ω			
9	$\frac{1}{4}$ W	270 Ω			
6	$\frac{1}{4}$ W	330 Ω	L	INDUCTOR	
8	$\frac{1}{4}$ W	8.2K Ω	2	RFC	250 μ H
7	$\frac{1}{4}$ W	22K Ω	101	OUTPUT COIL	#00054
1,4	$\frac{1}{4}$ W	100K Ω			
10	$\frac{1}{2}$ W	1K Ω			
VFO BUFF AMP UNIT					
C	CAPACITOR		PB	PRINTED CIRCUIT BOARD	
DIPPED MICA			1310(A~Z)	VFO BUFF AMP BOARD	
6,8	500WV	100PF			
1,2	500WV	650PF	Q	TRANSISTOR	
9	500WV	2000PF	1	2SC735Y	
CERAMIC DISC					
3,5,7,10~13	50WV	0.01 μ F			
CERAMIC T.C			R	RESISTOR	
4	NPO 50WV	10PF	3	$\frac{1}{4}$ W	120 Ω
			5	$\frac{1}{4}$ W	220 Ω
			2	$\frac{1}{4}$ W	4.7K Ω
L	INDUCTOR		1	$\frac{1}{4}$ W	15K Ω
1~3	RFC	250 μ H	4	$\frac{1}{2}$ W	1K Ω
105	RFC	1K32T			
			C	CAPACITOR	
CLARI BOARD			DIPPED MICA		
PB	PRINTED CIRCUIT BOARD		1	500WV	80PF
1308(A~Z)	CLARI BOARD		7	500WV	400PF
			6	500WV	680PF
			4	500WV	1000PF
D	DIODE		5	500WV	5000PF
1	Varactor	1S2236	CERAMIC DISC		
			2,3	50WV	0.01 μ F
R	RESISTOR				
1	$\frac{1}{4}$ W	10K Ω	L	INDUCTOR	
			102	TRAP COIL	
			103	OUTPUT COIL 1K32T	
C	CAPACITOR				
CERAMIC DISC			IF TRAP A UNIT		
1	50WV	0.01 μ F	PB	PRINTED CIRCUIT BOARD	
FIX UNIT			1548(A~Z)	TRAP BOARD A	
PB	PRINTED CIRCUIT BOARD				
1311(A~Z)	FIX BOARD		R	RESISTOR	
			1	$\frac{1}{4}$ W	1.5K Ω
Q	FET				
1	2SK19GR		C	CAPACITOR	
			DIPPED MICA		
D	DIODE		1,2	500WV	1500PF
1	Varactor	1S2236			
			T	TRANSFORMER	
XS	CRYSTAL SOCKET		123	TRAP COIL R12-4434	
1	S-14				
R	RESISTOR		RL	RELAY	
2	$\frac{1}{4}$ W	56 Ω	1	AE5343	
3	$\frac{1}{4}$ W	100 Ω	IF TRAP B UNIT		
1,4	$\frac{1}{4}$ W	100K Ω	PB	PRINTED CIRCUIT BOARD	
			1309(A~Z)	TRAP BOARD B	
C	CAPACITOR		R	RESISTOR	
DIPPED MICA			1	$\frac{1}{4}$ W	820 Ω
5	500WV	20PF			

VR	POTENTIOMETER		Q	FET & TRANSISTOR	
1	TR-11R	500Ω B	1	FET 3SK35Y	
			2	FET 2SK19GR	
			3	Tr 2SC372Y	
C	CAPACITOR		D	DIODE	
	DIPPED MICA		1,2	Ge 1S1007	
1,2	500WV	700PF	3	Zener WZ-090	
T	TRANSFORMER		X	CRYSTAL	
124	TRAP COIL	R12-4437	1	HC-18/U ★24MHz	
			2	HC-18/U 22MHz	
FM UNIT					
PB	PRINTED CIRCUIT BOARD		R	RESISTOR	
1269(A-Z)			14	¼W	56Ω
			9,12	¼W	100Ω
Q	TRANSISTOR & IC		7,13,15,23	¼W	220Ω
1~5	2SC372Y		22	¼W	470Ω
6	TA 7061AP		18,19	¼W	1KΩ
			11,21	¼W	3.3KΩ
			8,20	¼W	10KΩ
D	DIODE		3,5	¼W	15KΩ
1~4	Ge 1S188FM		1,2,6	¼W	56KΩ
5	Zener AW0109		4,10,16,17	¼W	100KΩ
R	RESISTOR		C	CAPACITOR	
10	¼W	22Ω		DIPPED MICA	
18	¼W	220Ω	3,16	50WV	3PF
24	¼W	470Ω	4,11	50WV	8PF
2,16	¼W	1KΩ	1	50WV	12PF
8,9,21,23	¼W	2.2KΩ	9	50WV	15PF
13	¼W	3.3KΩ	6,12,21	50WV	20PF
1,20	¼W	4.7KΩ	14,17,20	50WV	30PF
5,7,11,12	¼W	10KΩ	25	50WV	60PF
4	¼W	15KΩ	2	50WV	70PF
17	¼W	22KΩ	23	50WV	80PF
25	¼W	33KΩ	10	50WV	130PF
14,15	¼W	47KΩ		CERAMIC DISC	
3	¼W	56KΩ	5,7,8,13,15,18,19	50WV	0.01μF
19,22	¼W	330KΩ	20,24		
26	½W	100Ω			
C	CAPACITOR		T	TRANSFORMER	
	DIPPED MICA		611	ANT COIL	#1006
9	500WV	30PF	612~614	BPF COIL	#1006
10	500WV	150PF	615,616	OUTPUT COIL	R12-4423
6	500WV	200PF	617,618	OSC COIL	R12-4425
7,8	500WV	300PF			
	CERAMIC DISC		L	INDUCTOR	
14,16	50WV	0.001μF	1,2	RFC	10μH
17,20	50WV	0.01μF			
4,11~13,15,18,23	50WV	0.047μF			
	MYLAR				
19,22	50WV	0.0047μF			
5,24	50WV	0.1μF			
	ELECTROLYTIC		2m CONVERTER UNIT		
1,3	16WV	1μF	PB	PRINTED CIRCUIT BOARD	
25	16WV	4.7μF	1306(A-Z)	2m BOARD	
26	16WV	10μF	Q	FET & TRANSISTOR	
21	16WV	22μF	1	FET 3SK40M	
2	16WV	100μF	2	FET 2SK19Y	
			3	Tr 2SC372Y	
			4	Tr 2SC784R	
T	TRANSFORMER		D	DIODE	
301	FM DET COIL A	R12-4129	1,2	Ge 1S1007	
302	FM DET COIL B	R12-4424	4	Si 1S1555	
			3	Zener WZ090	
6m CONVERTER UNIT					
PB	PRINTED CIRCUIT BOARD		X	CRYSTAL	
1305(A-Z)	6m BOARD				

1	HC-18/U	★39.333MHz	
2	HC/18/U	38.666MHz	
R RESISTOR			
7, 10, 22	¼W		100Ω
6, 18	¼W		220Ω
17	¼W		470Ω
23	¼W		560Ω
13, 14	¼W		1KΩ
9	¼W		1.5KΩ
16	¼W		3.3KΩ
20	¼W		4.7KΩ
3, 15, 19	¼W		10KΩ
21	¼W		22KΩ
1, 2, 4	¼W		56KΩ
5, 8, 11, 12	¼W		100KΩ
C CAPACITOR			
DIPPED MICA			
9	50WV		3PF
18, 21			8PF
2, 5, 13, 17			20PF
15			25PF
7, 10			30PF
CERMIC DISC			
19	50WV		0.001μF
1, 3, 4, 6, 8, 11, 12	50WV		0.01μF
14, 16, 20, 22			
T TRANSFORMER			
211	ANT COIL		
212, 213, 215	BPF COIL A		
214	BPF COIL B		
216, 217	OUTPUT COIL	R12-4423	
218	OSC COIL	R12-4425	
219	OSC COIL	R12-4427	
220	OSC COIL	R12-4426	
L INDUCTOR			
1, 2	RFC		10μH

